

Association d'antibiotiques:

- 1. modèles planctoniques**
- 2. biofilms**

Modèles planctoniques

Un article de synthèse...

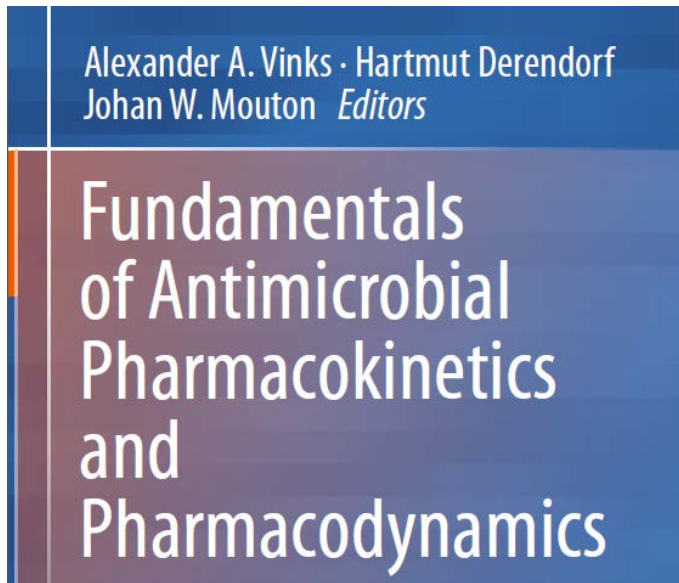

ISBN 978-0-387-75612-7 ISBN 978-0-387-75613-4 (eBook)

DOI [10.1007/978-0-387-75613-4](https://doi.org/10.1007/978-0-387-75613-4)

Springer New York Heidelberg Dordrecht London

Chapter 8 Drug–Drug Combinations

John Turnidge

J. Turnidge, M.B., B.S., F.R.A.C.P., F.R.C.P.A., F.A.S.M. (✉)
Department of Pathology, University of Adelaide and SA Pathology,
Women's and Children's Hospital, 72 King William Road, North Adelaide,
South Australia 5006, Australia

Pourquoi associer ?

Table 8.1 Rationale for drug combinations

Rationale	Target	Example
“Synergy”	Gram-negative bacteria	β -lactam + aminoglycoside β -lactam + fluoroquinolone Trimethoprim–sulfamethoxazole
Inhibition of degrading bacterial enzymes	Gram-negative bacteria <i>Staphylococcus</i> species	β -lactam + β -lactamase inhibitor
Inhibition of degrading human enzymes	Gram-negative and Gram-positive bacteria	Imipenem + cilastatin
Reduced toxicity from reduced dosage	<i>Cryptococcus neoformans</i>	Amphotericin B + flucytosine
Broadening of spectrum	Polymicrobial infections	β -lactam + aminoglycoside
Prevention of resistance selection during treatment	<i>Pseudomonas aeruginosa</i> <i>Mycobacterium</i> species Human immunodeficiency virus	β -lactam + aminoglycoside Combination antituberculous therapy Combination antiretroviral therapy (HAART)
Antibacterial plus antitoxin action	Panton-valentine leukocidin producing <i>S. aureus</i>	Cell-wall active agent + clindamycin or linezolid

La résistance se développe facilement en monothérapie

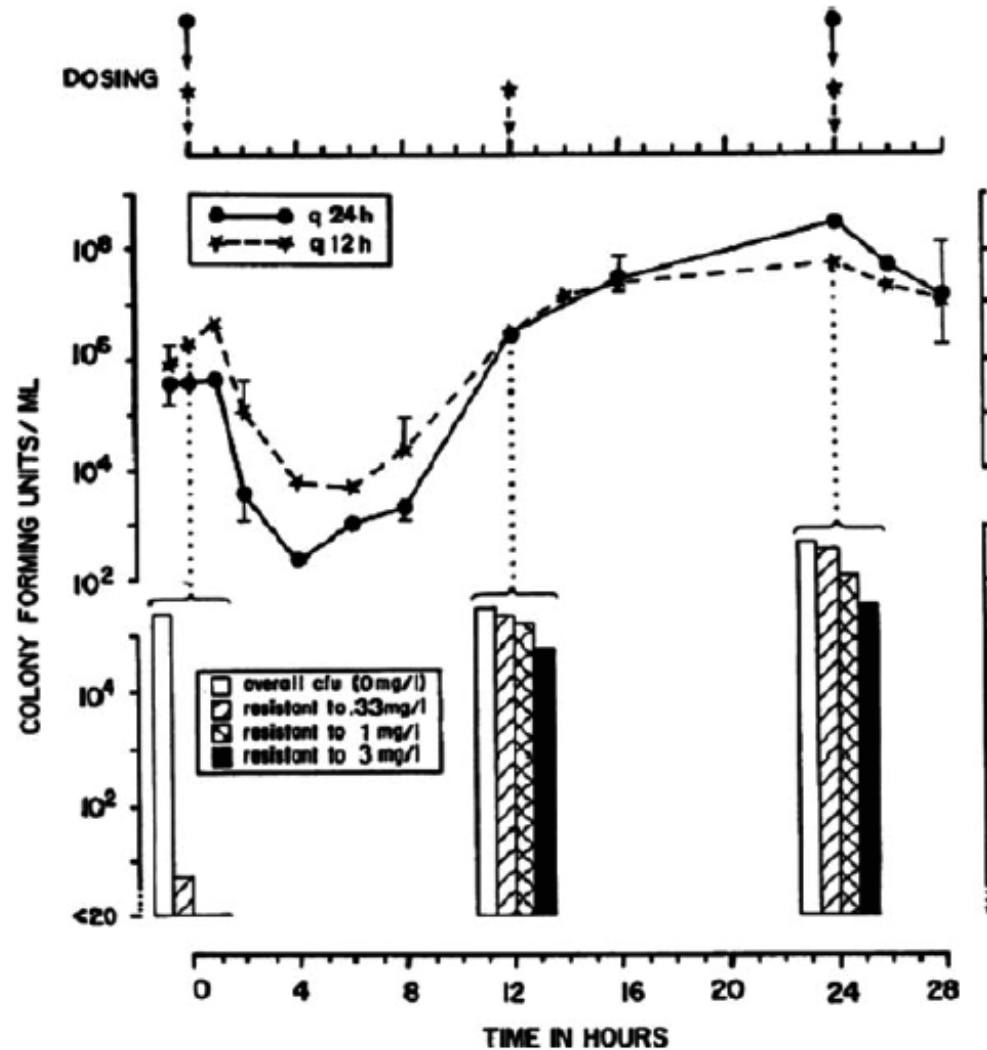

Fig. 8.1 Emergence of resistance to enoxacin in *P. aeruginosa* in an in vitro pharmacodynamic model (from Blaser et al. 1987)

Il y a de nombreuses preuves que l'association d'antibiotiques diminue le risque de résistance *in vitro*

1. Combinations of β -lactams with aminoglycosides prevent the selection of aminoglycoside-resistant mutants (Blaser et al. 1985 ; McGrath et al. 1993 ; Zelenitsky et al. 1998) and β -lactam-resistant mutants (Drusano et al. 2012), or both (Zinner et al. 1986).
2. Combinations of β -lactams with fluoroquinolones prevent the emergence of fluoroquinolone-resistant mutants (Lister et al. 2006; Louie et al. 2010), combinations of β -lactams with colistin prevent the emergence of fluoroquinolone resistant mutants (Gunderson et al. 2003; Bergen et al. 2011).
3. the combination of a carbapenem with an aminoglycoside or fluoroquinolone can be effective in killing and preventing resistance emergence even for strains that are not susceptible to one or both agents (Lister et al. 2006); similar observations have been made with colistin and a carbapenem for a colistin-resistant strain (Bergen et al. 2011).
4. Killing can occur even when the combination of a β -lactam and aminoglycoside are below the MICs throughout (den Hollander et al. 1997).
5. etc...

L'association d'antibiotiques diminue le risque de résistance *in vivo* (souris neutropénique)

36 similar studies with a large
number of antibiotics

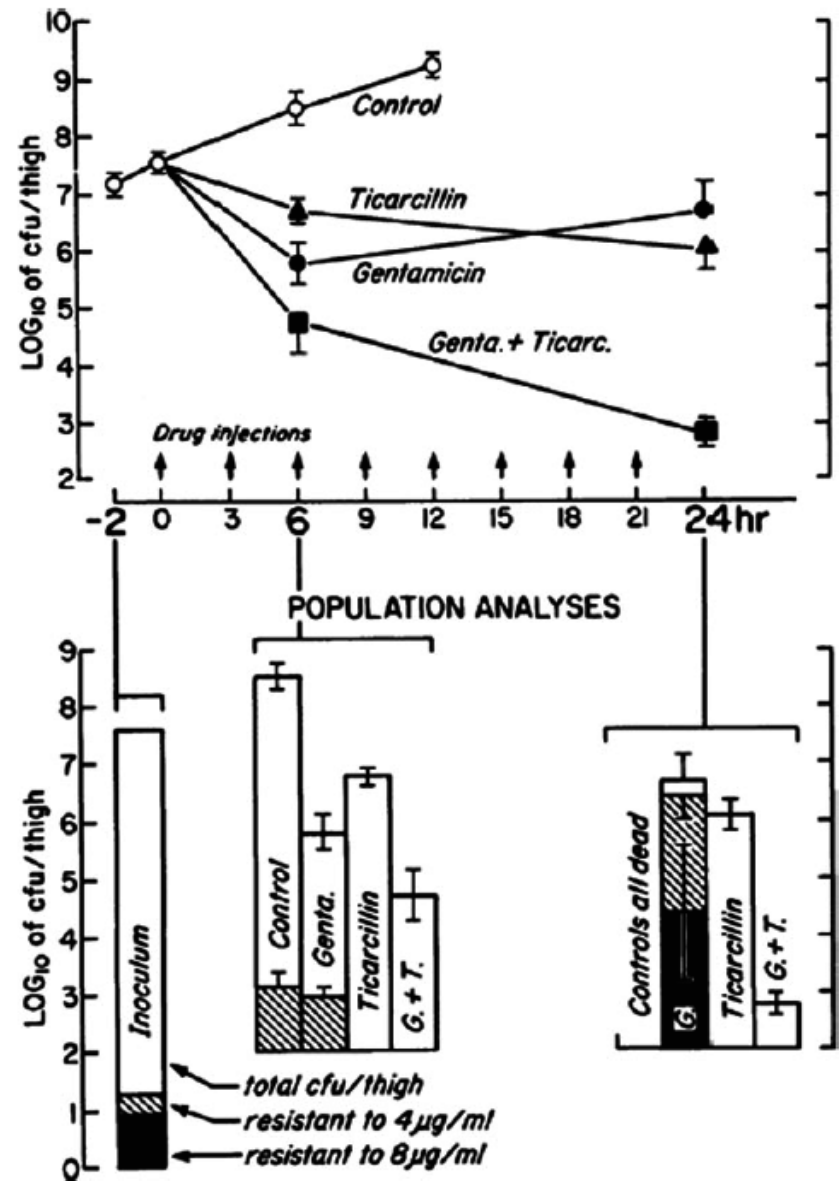

Fig. 8.2 Selection of resistance during treatment and suppression by combination therapy (from Gerber et al. 1982)

Data with a pharmacodynamic model of infected fibrin clot

Houlihan HH, Stokes DP, Rybak MJ (2000) Pharmacodynamics of vancomycin and ampicillin alone and in combination with gentamicin once daily or thrice daily against *Enterococcus faecalis* in an in vitro infection model. J Antimicrob Chemother 46:79–86

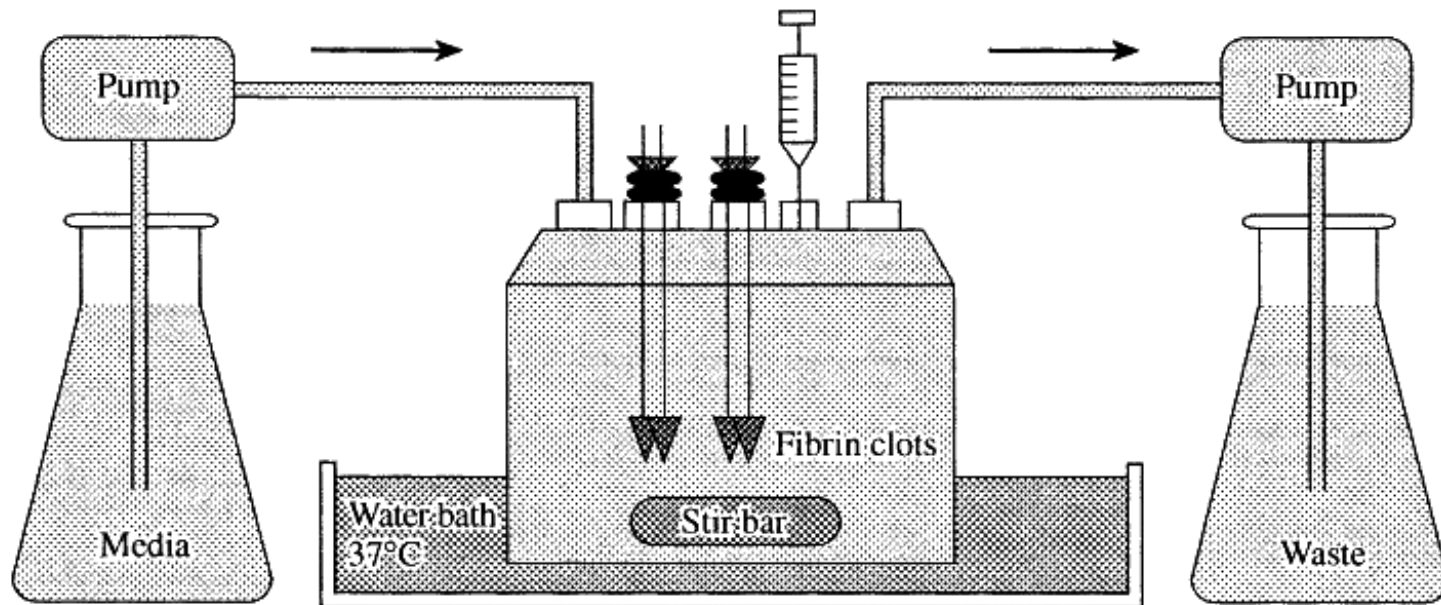

Figure 1. *In vitro* infection model with FPCs.

Data with a pharmacodynamic model of infected fibrin clot

Houlihan HH, Stokes DP, Rybak MJ (2000) Pharmacodynamics of vancomycin and ampicillin alone and in combination with gentamicin once daily or thrice daily against *Enterococcus faecalis* in an in vitro infection model. J Antimicrob Chemother 46:79–86

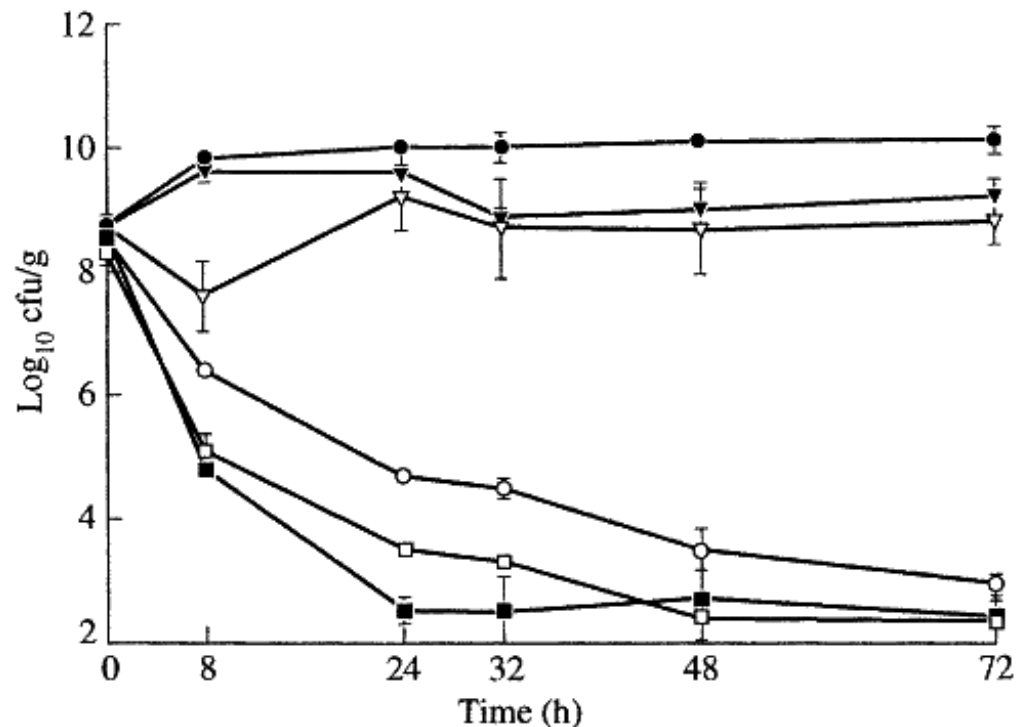

Figure 2. Bactericidal activity of ampicillin, gentamicin and the combination of ampicillin and gentamicin either q8h or q24h against *E. faecalis* OG1X. ●, Growth control; ▼, gentamicin q8h; ▽, gentamicin q24h; ○, ampicillin q6h; ■, ampicillin q6h + gentamicin q8h; □, ampicillin q6h + gentamicin q24h.

Data with a pharmacodynamic model of infected fibrin clot

Houlihan HH, Stokes DP, Rybak MJ (2000) Pharmacodynamics of vancomycin and ampicillin alone and in combination with gentamicin once daily or thrice daily against *Enterococcus faecalis* in an in vitro infection model. J Antimicrob Chemother 46:79–86

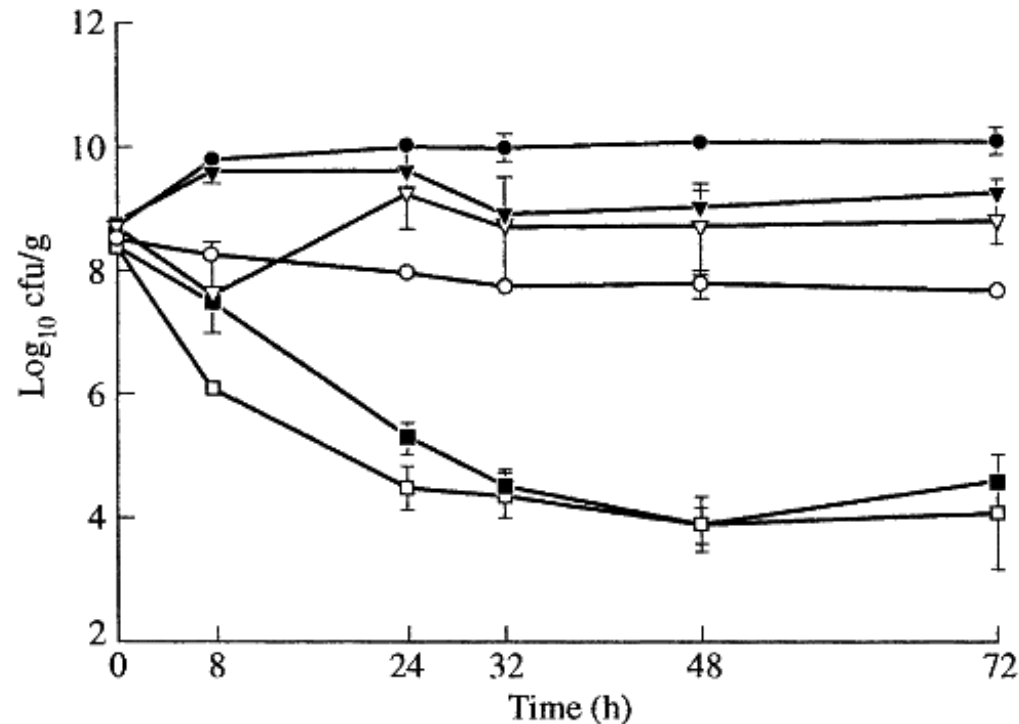

Figure 3. Bactericidal activity of vancomycin, gentamicin and the combination of vancomycin and gentamicin either q8h or q24h against *E. faecalis* OG1X. ●, Growth control; ▼, gentamicin q8h; ▽; gentamicin q24h; ○, vancomycin q12h; ■, vancomycin q12h + gentamicin q8h; □, vancomycin q12h + gentamicin q24h.

Data with a pharmacodynamic model of infected fibrin clot

Houlihan HH, Stokes DP, Rybak MJ (2000) Pharmacodynamics of vancomycin and ampicillin alone and in combination with gentamicin once daily or thrice daily against *Enterococcus faecalis* in an in vitro infection model. J Antimicrob Chemother 46:79–86

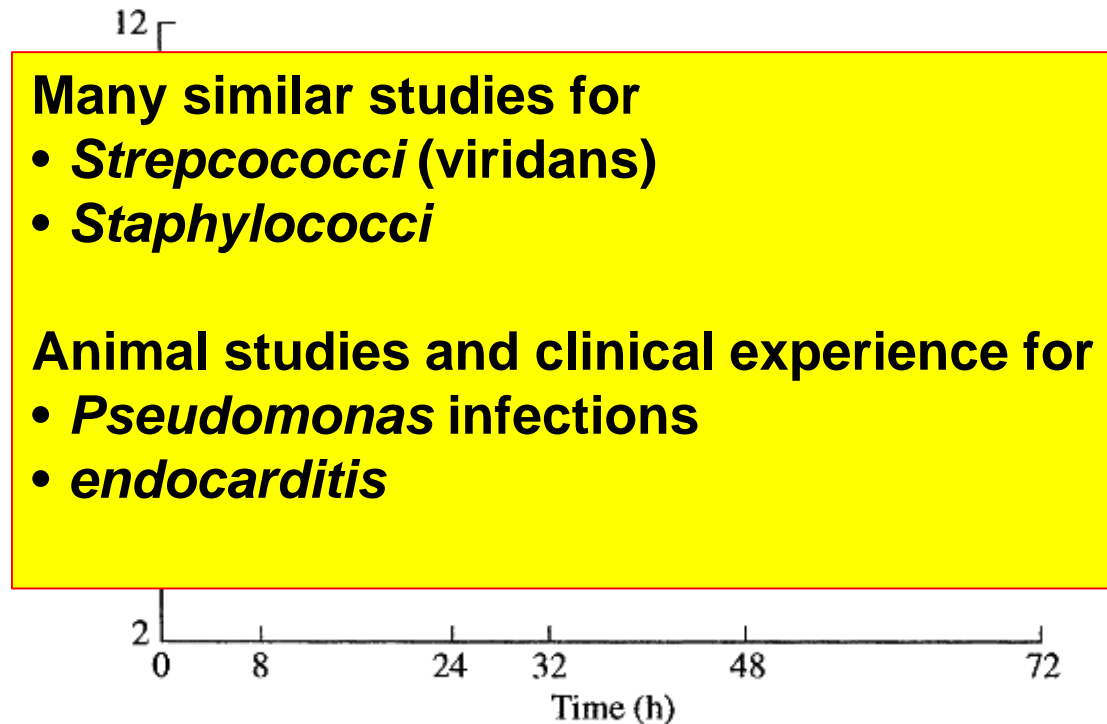

Figure 3. Bactericidal activity of vancomycin, gentamicin and the combination of vancomycin and gentamicin either q8h or q24h against *E. faecalis* OG1X. ●, Growth control; ▼, gentamicin q8h; ▽; gentamicin q24h; ○, vancomycin q12h; ■, vancomycin q12h + gentamicin q8h; □, vancomycin q12h + gentamicin q24h.

A conclusion that calls for the future

Conclusions

Combination therapy is widely used in the management of serious *P. aeruginosa* infection and Gram-positive endocarditis. Despite extensive in vitro static, pharmacodynamic and animal model studies, uncertainties persist about the utility of combinations, especially given the potential for toxicity associated with concomitant aminoglycoside use. Ultimately, an in vitro or animal model of the pharmacodynamic interaction of drug classes that can be shown to predict clinical outcomes is still required. Such a model does not currently exist.



Modèles de biofilms...

Biofilms: what are we speaking about ?

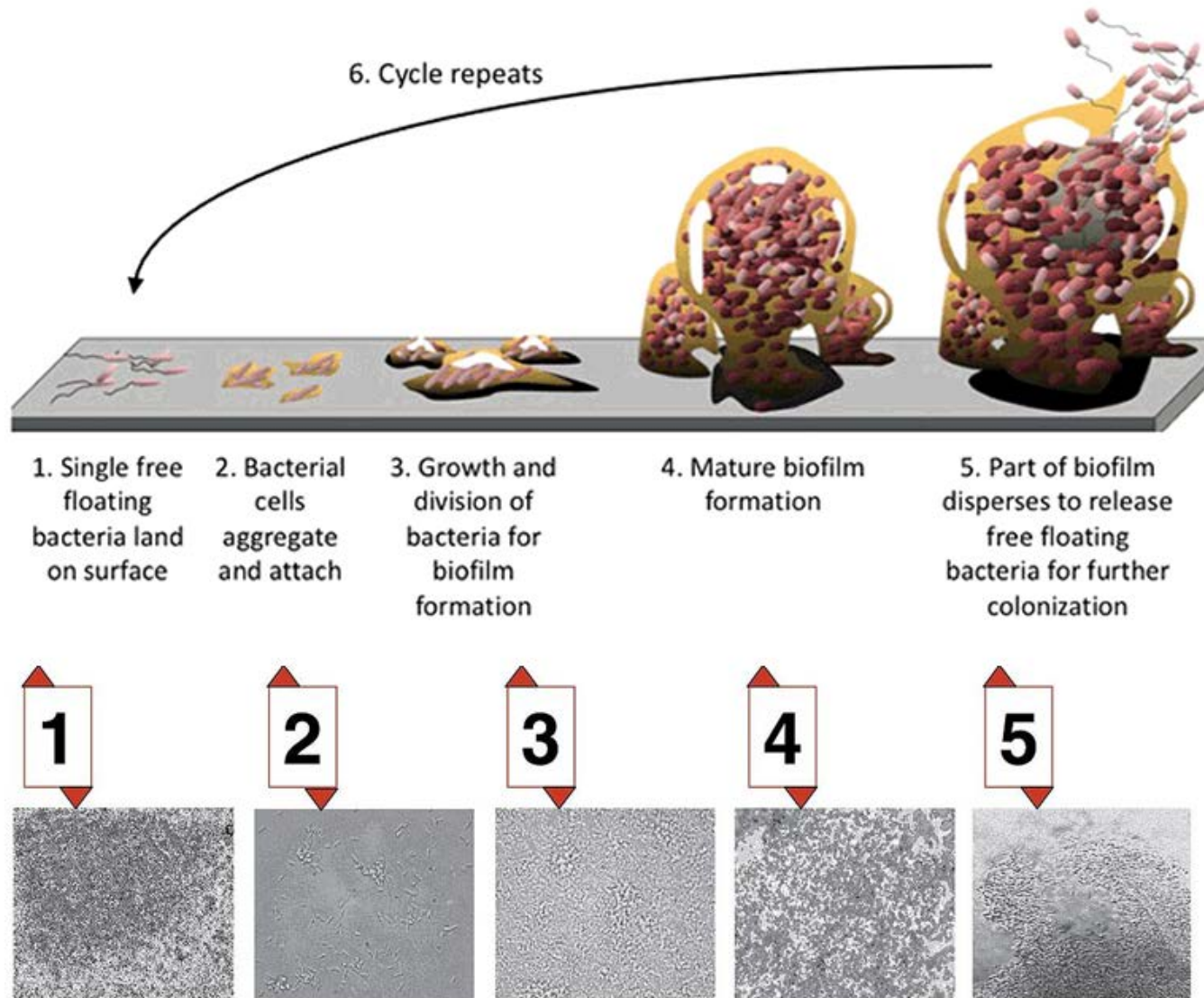

<http://www.bayarealyme.org/blog/straight-talk-biofilms-new-answer-treating-lyme-disease/>
Last visited: 28 Sep 2017

Biofilms in human infections

Biofilms are associated to 65^a-80^b % of human infections and can colonize virtually all organs ...

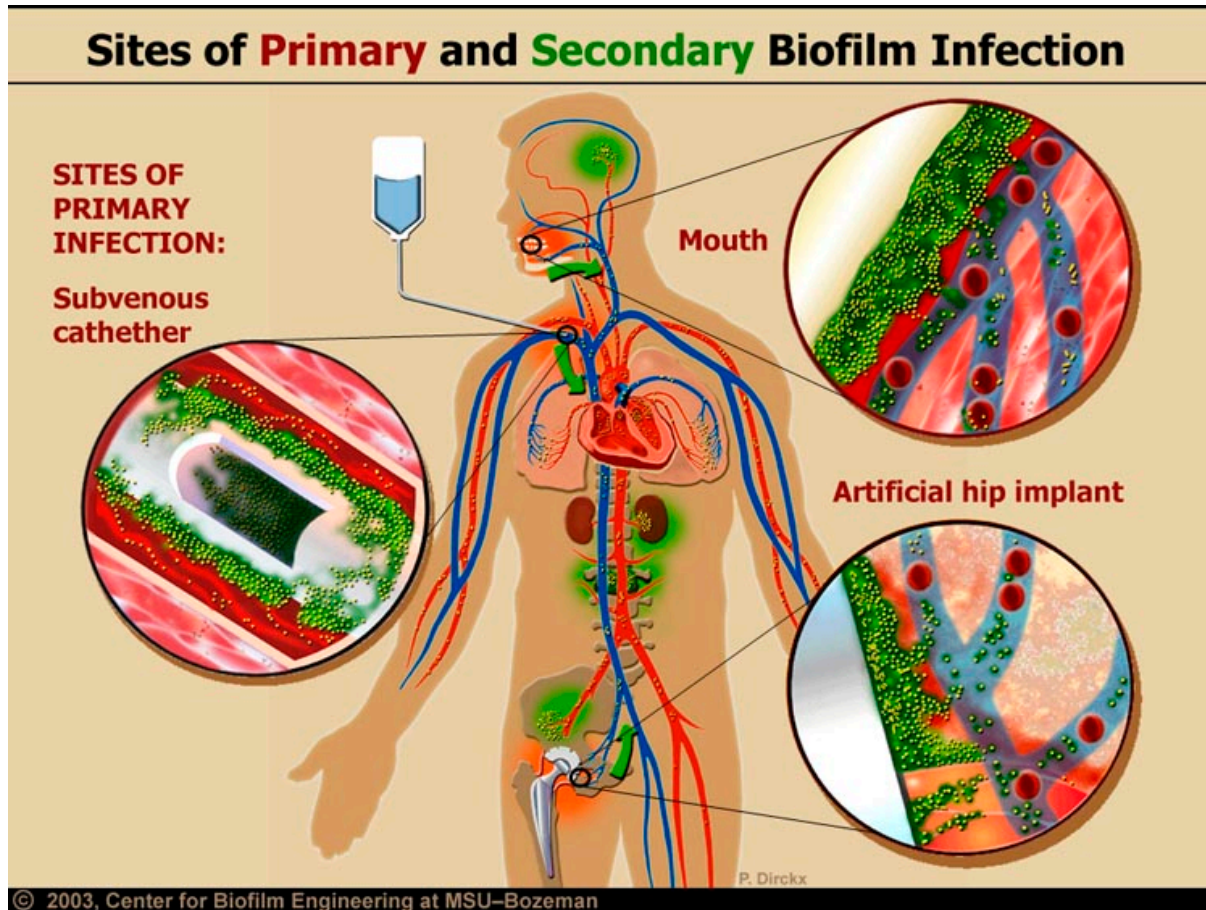

^aCDC 1999; ^bLewis et al, Nat Rev Microbiol. 2007; 5:48-56

Biofilms: what can you do ?

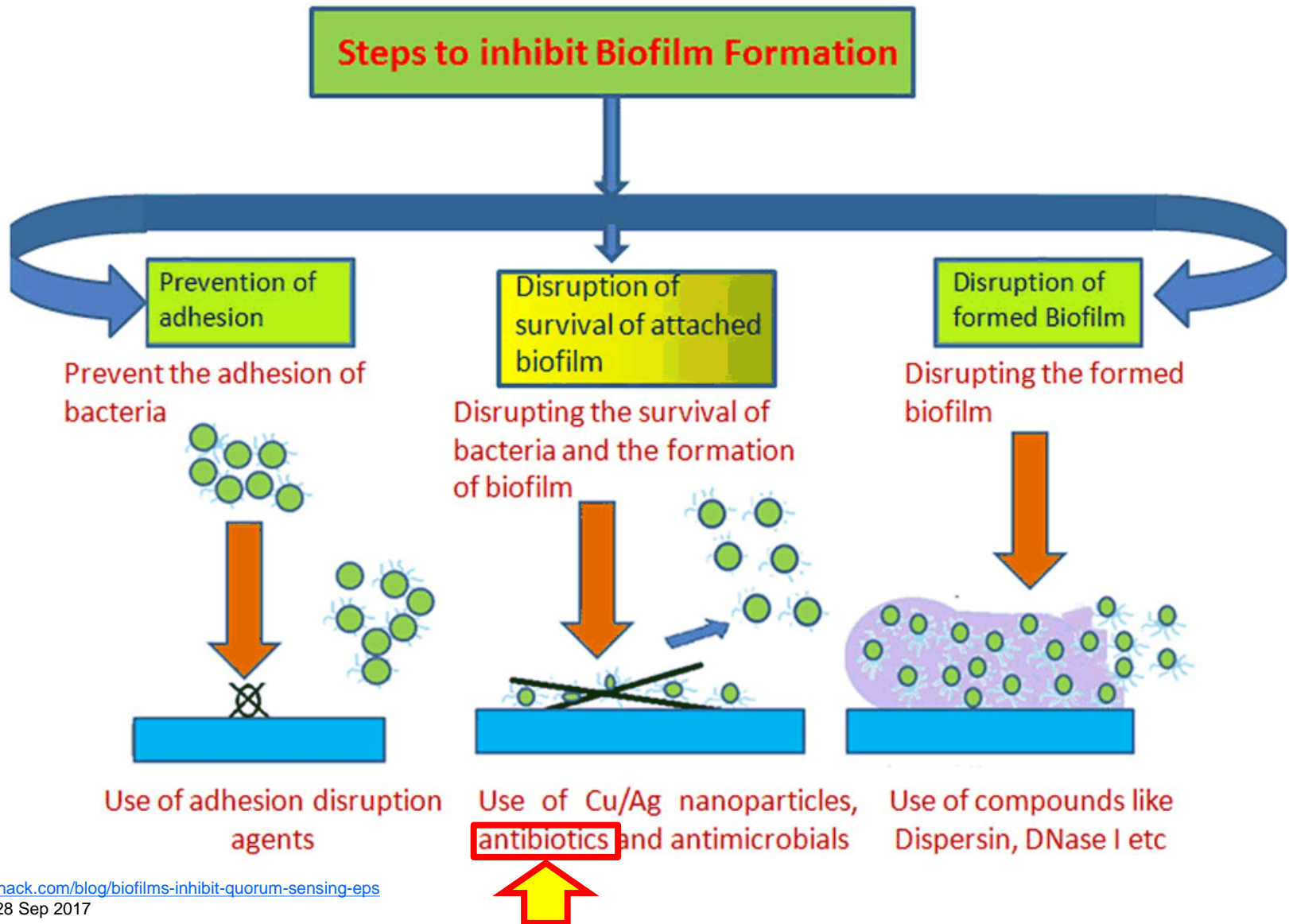

<https://mybiohack.com/blog/biofilms-inhibit-quorum-sensing-eps>
Last visited: 28 Sep 2017

PK/PD parameters in biofilms

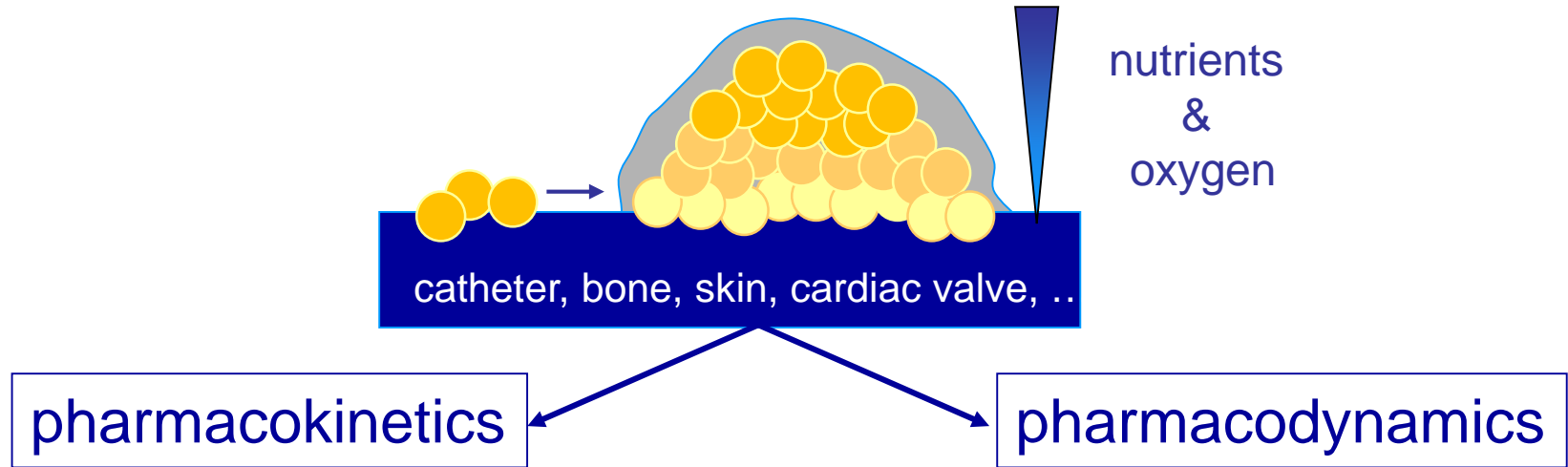

- diffusibility through the matrix
- bioavailability within the biofilm
- access to bacteria
- efflux out of bacteria

- bacterial responsiveness (metabolic activity of bacteria)
- antibiotic expression of activity (local environment [O_2 , pH, ..])



Janssen, Nature 2009



Pharmacodynamic model for antibiotic activity

An example with a **young** biofilm of *S. aureus* - ATCC MSSA

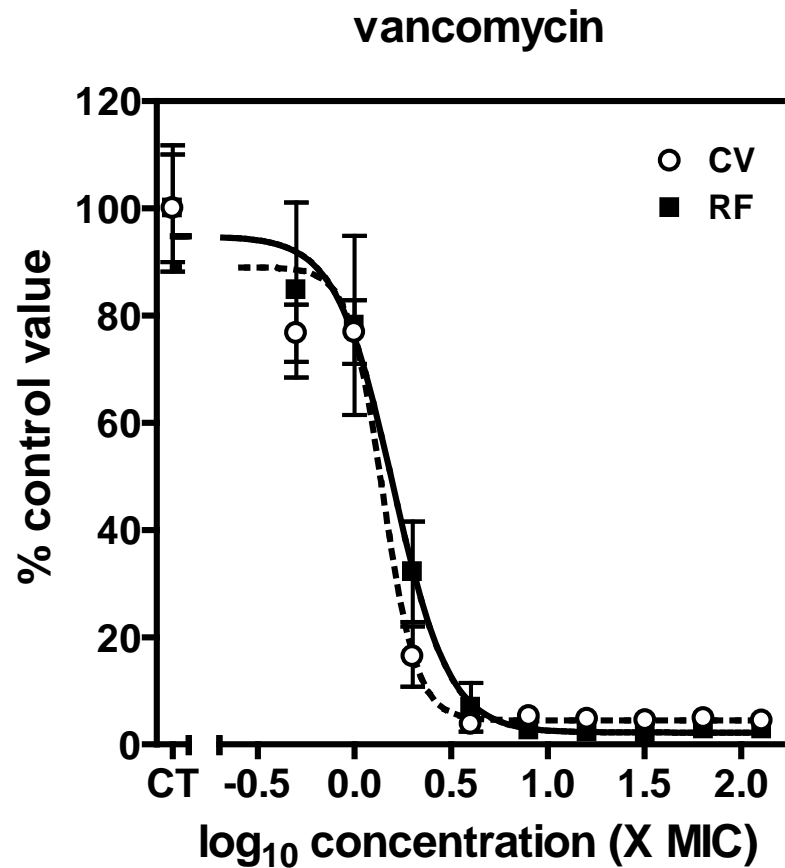

Bauer, Siala *et al*, Antimicrob Ag Chemother. 2013;57:2726-37 – PMID: [23571532](https://pubmed.ncbi.nlm.nih.gov/23571532/)

Pharmacodynamic model for antibiotic activity

An example with a **young** biofilm of *S. aureus* - ATCC MSSA

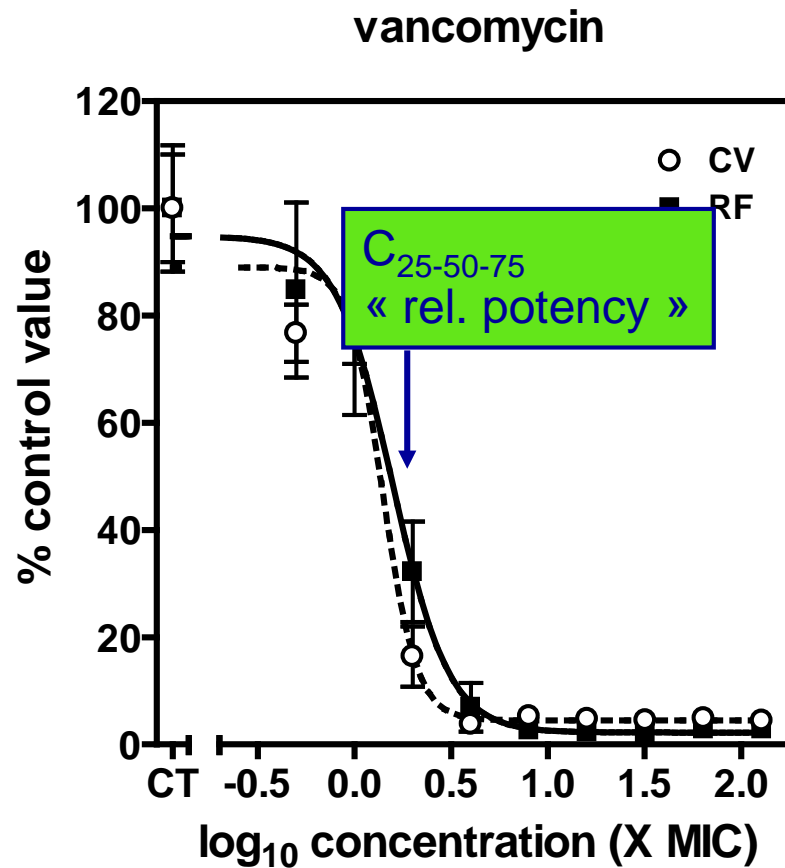

Bauer, Siala *et al*, Antimicrob Ag Chemother. 2013;57:2726-37 – PMID: [23571532](https://pubmed.ncbi.nlm.nih.gov/23571532/)

Pharmacodynamic model for antibiotic activity

An example with a **young** biofilm of *S. aureus* - ATCC MSSA

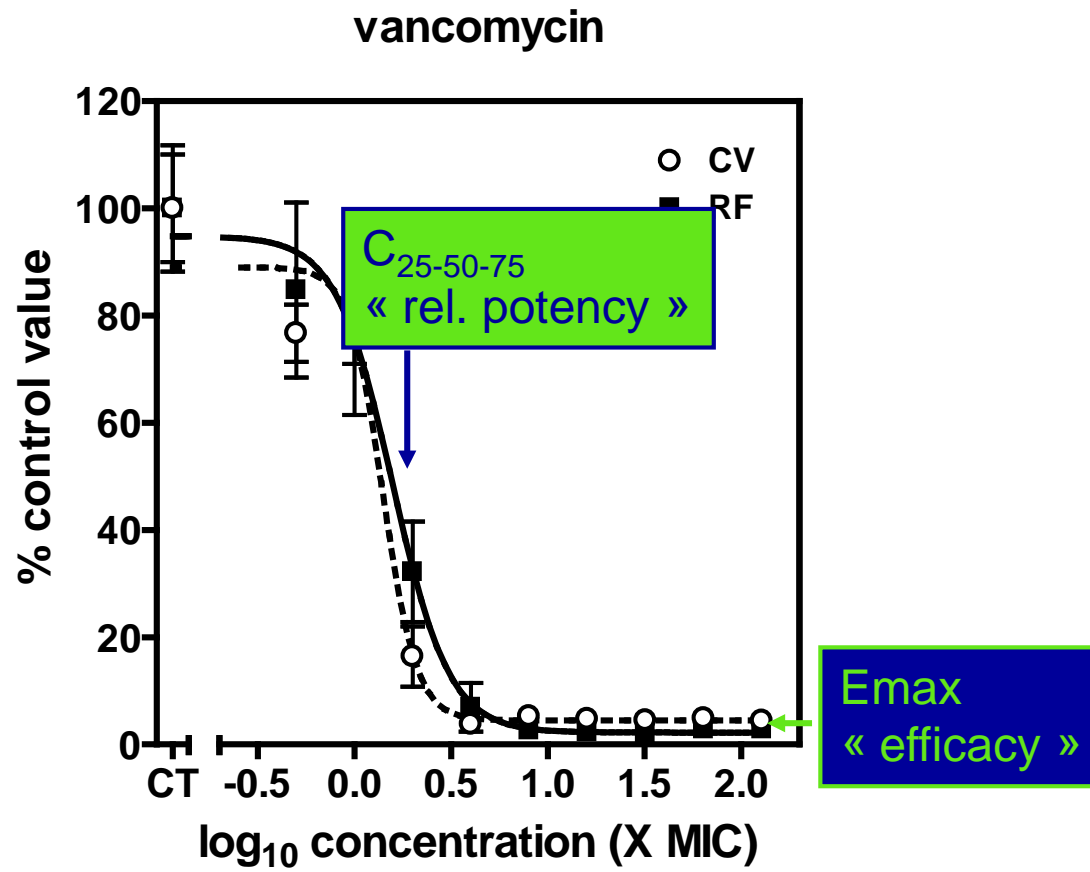

Bauer, Siala *et al*, Antimicrob Ag Chemother. 2013;57:2726-37 – PMID: [23571532](https://pubmed.ncbi.nlm.nih.gov/23571532/)

Pharmacodynamic model for antibiotic activity

Young vs. mature biofilm of *S. aureus* - ATCC MSSA

vancomycin vs. young biofilm (6h)

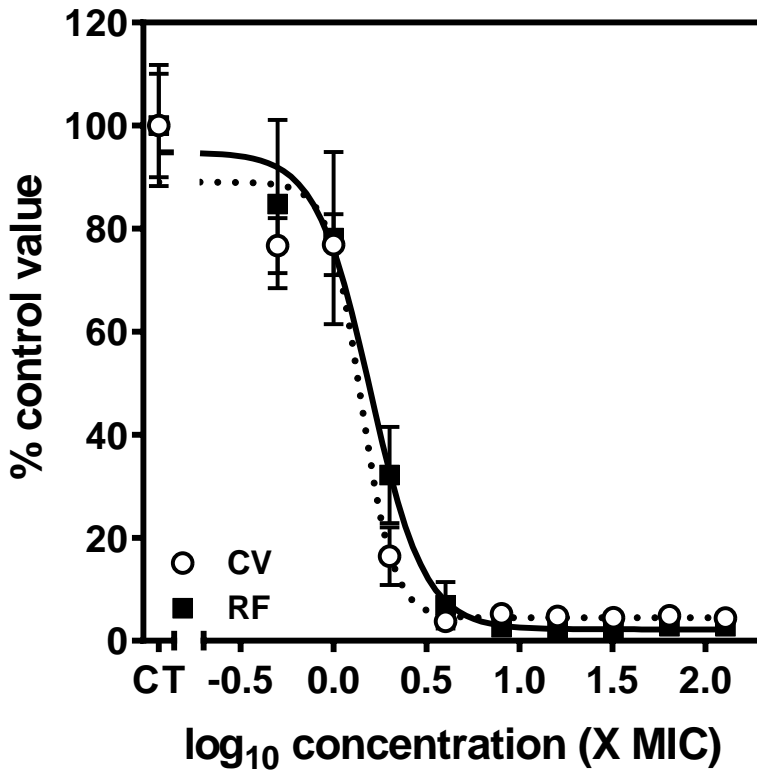

vancomycin vs mature biofilm (24h)

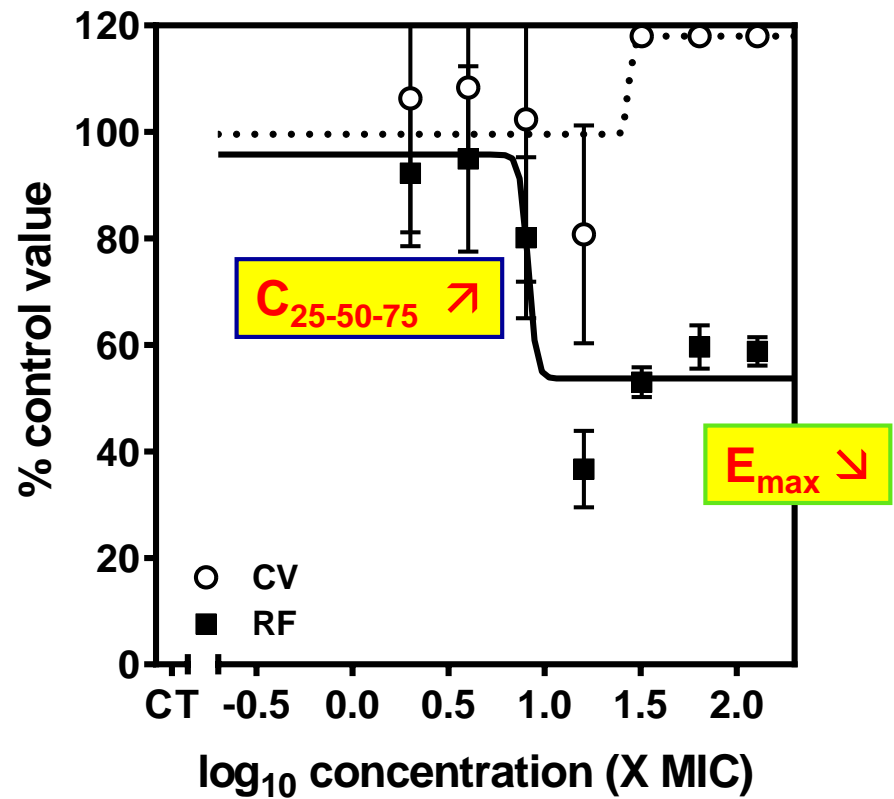

Bauer, Siala *et al*, Antimicrob Ag Chemother. 2013;57:2726-37 – PMID: [23571532](https://pubmed.ncbi.nlm.nih.gov/23571532/)

Pharmacodynamic model for antibiotic activity

Young vs mature biofilm *S. aureus* - ATCC MSSA

most antibiotics act poorly on mature biofilms, but some may do better than others ...

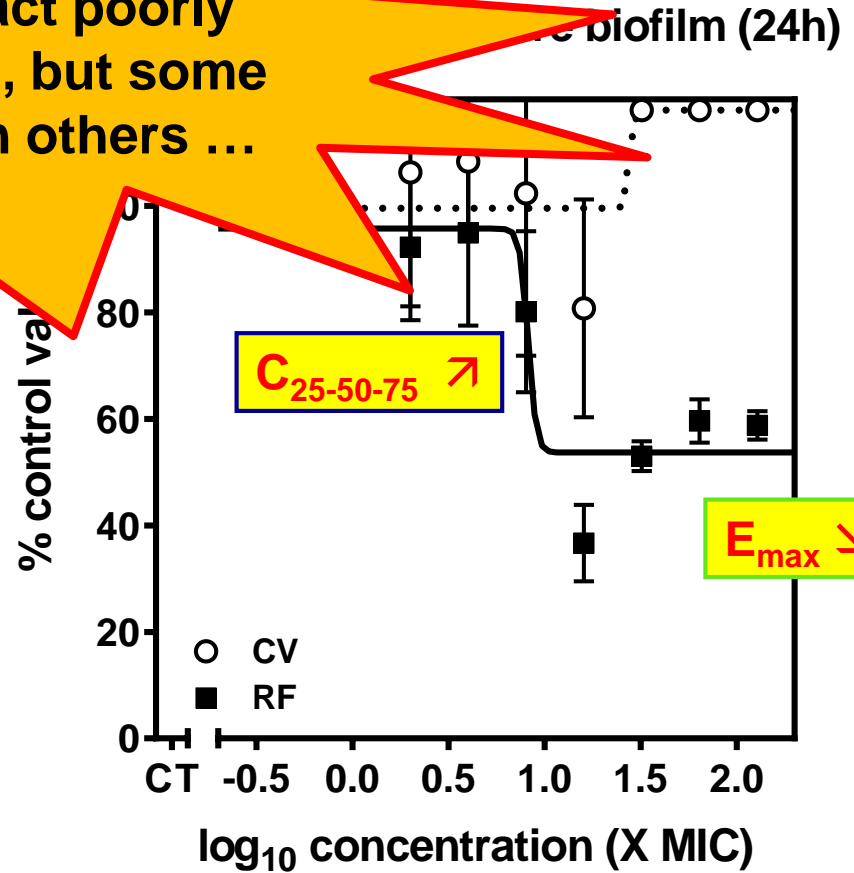
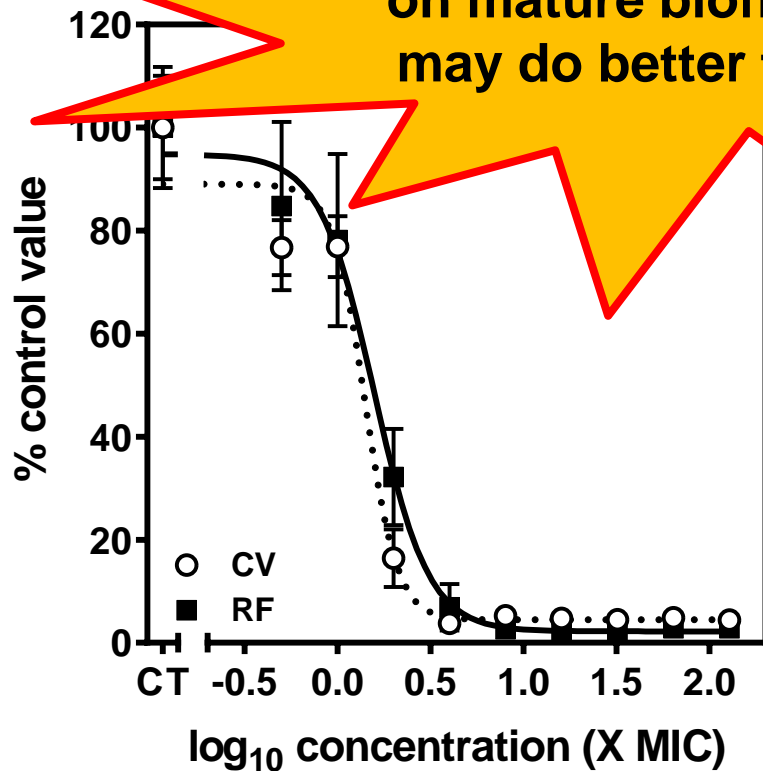

Bauer, Siala *et al*, Antimicrob Ag Chemother. 2013;57:2726-37 – PMID: [23571532](https://pubmed.ncbi.nlm.nih.gov/23571532/)

Delafloxacin, a new fluoroquinolone

DRUG EVALUATION

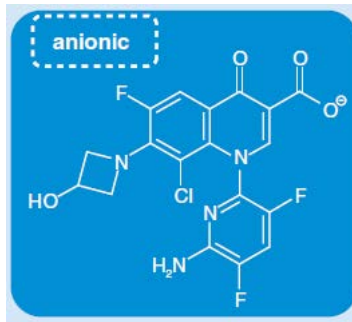

Delafloxacin, a non-zwitterionic fluoroquinolone in Phase III of clinical development: evaluation of its pharmacology, pharmacokinetics, pharmacodynamics and clinical efficacy

Françoise Van Bambeke*

ABSTRACT Delafloxacin is a fluoroquinolone lacking a basic substituent in position 7. It shows MICs remarkably low against Gram-positive organisms and anaerobes and similar to those of ciprofloxacin against Gram-negative bacteria. It remains active against most fluoroquinolone-resistant strains, except enterococci. Its potency is further increased in acidic environments (found in many infection sites). Delafloxacin is active on staphylococci growing intracellularly or in biofilms. It is currently evaluated as an intravenous and intravenous/oral stepdown therapy in Phase III trials for the treatment of complicated skin/skin structure infections. It was also granted as Qualified Infectious Disease Product for the treatment of acute bacterial skin and skin structure infections and community-acquired bacterial pneumonia, due to its high activity on pneumococci and atypical pathogens.

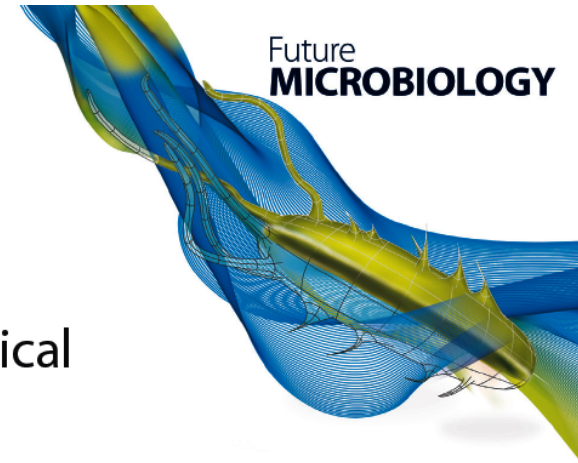

Comparison of antibiotic activity in confocal microscopy

Live/dead staining (antibiotics at 32 X MIC) – ATCC MRSA

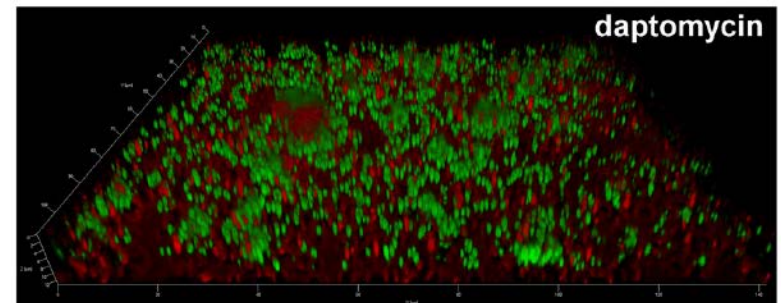
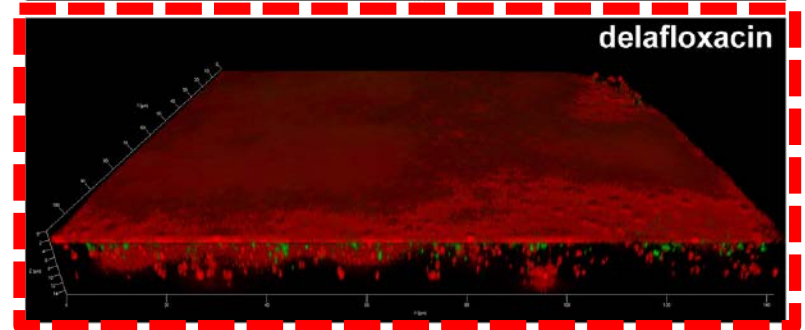
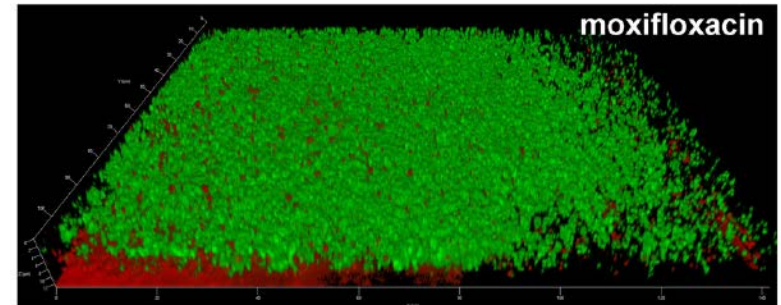
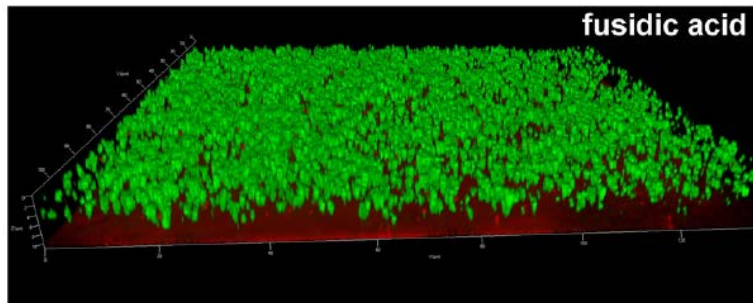
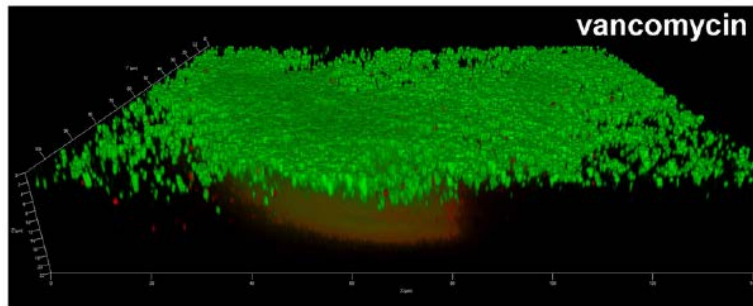
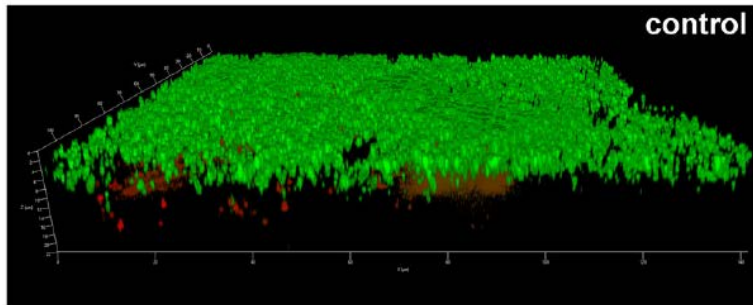

Bauer, Siala *et al*, Antimicrob Ag Chemother. 2013;57:2726-37 – PMID: [23571532](https://pubmed.ncbi.nlm.nih.gov/23571532/)

When one antibiotic (even at a large dose) is not enough...



<https://www.pinterest.com/pin/433682639086749225/>
Last visited: 28 Sep 2017

why not combining them at
their normal (and safe) human
doses ?



https://de.wikipedia.org/wiki/Heinrich_von_Opel
Last visited: 22 Oct 2016

Combining antibiotics in a dynamic model

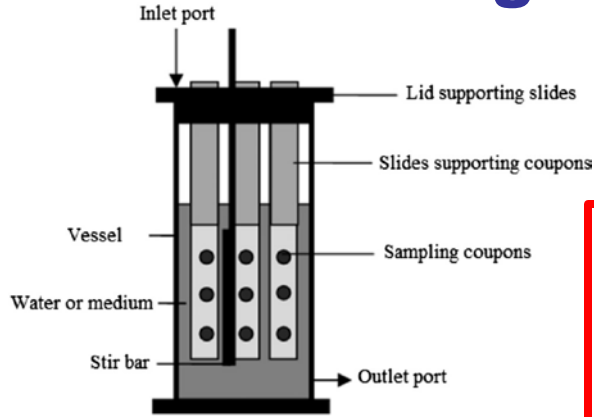

The CDC reactor:

Biofilms are grown on 12.7 mm diameter coupons, suspended in the bulk fluid by eight coupon holders and then exposed to antibiotic concentrations mimicking their human pharmacokinetics

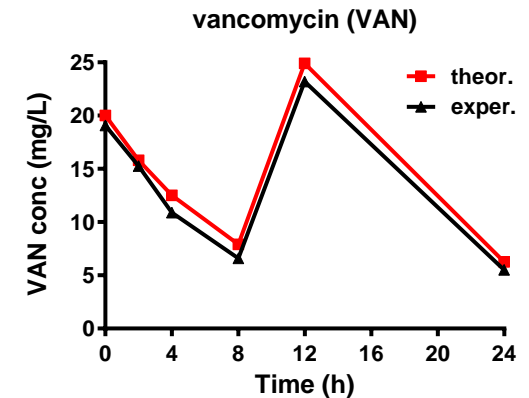
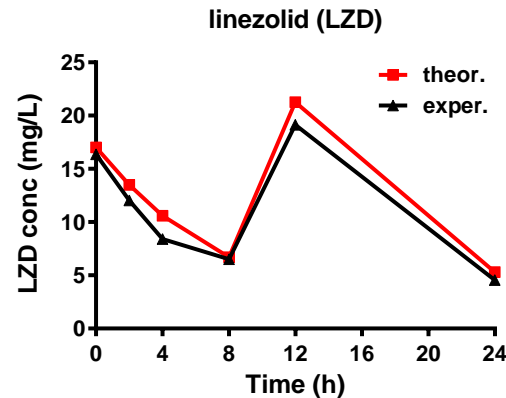
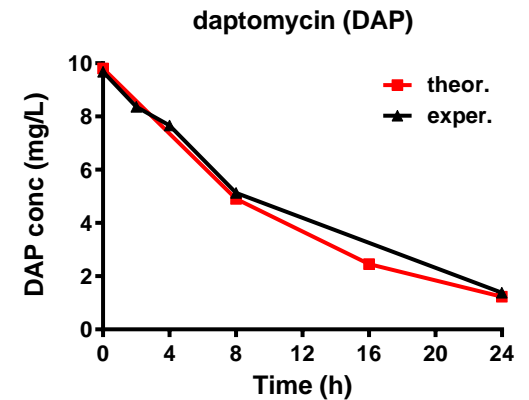
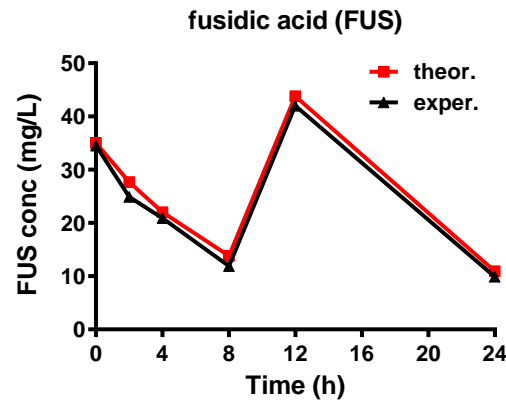

Combining antibiotics in a dynamic model

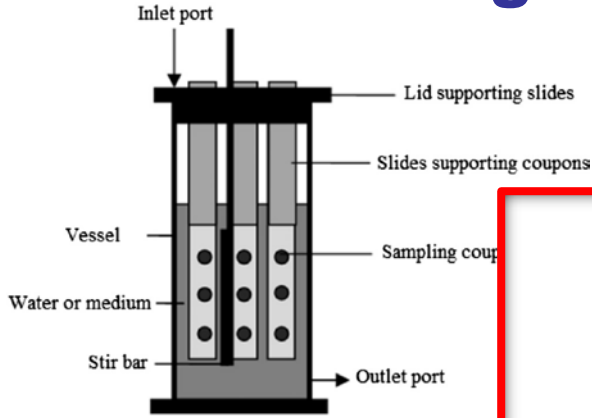

The CDC reactor:

Biofilms are grown on 12.7 mm diameter coupons, suspended in the bulk fluid by eight coupon holders and then exposed to antibiotic concentrations mimicking their human pharmacokinetics

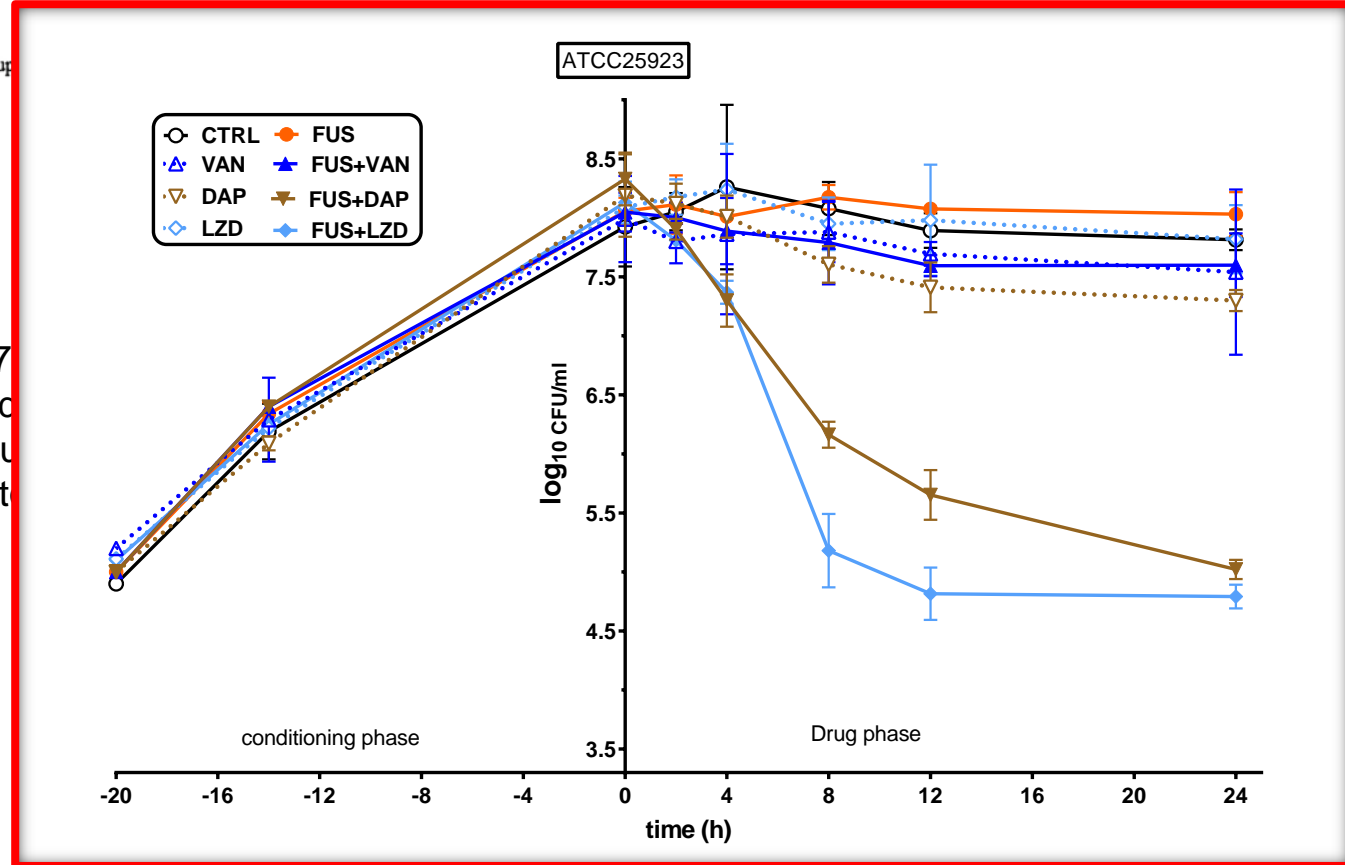

Combining antibiotics in a dynamic model

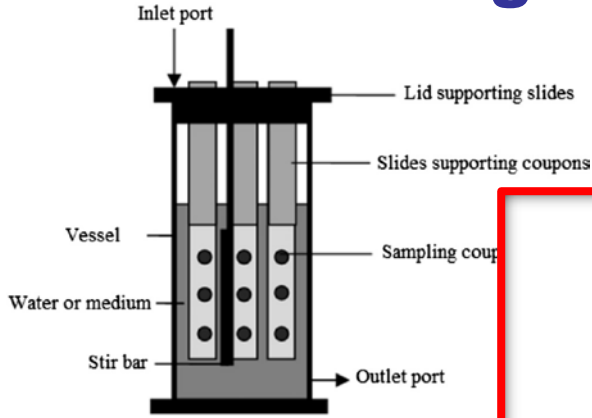

The CDC reactor:

Biofilms are grown on 12.7 mm diameter coupons, suspended in the bulk fluid by eight coupon holders and then exposed to antibiotic concentrations mimicking their human pharmacokinetics

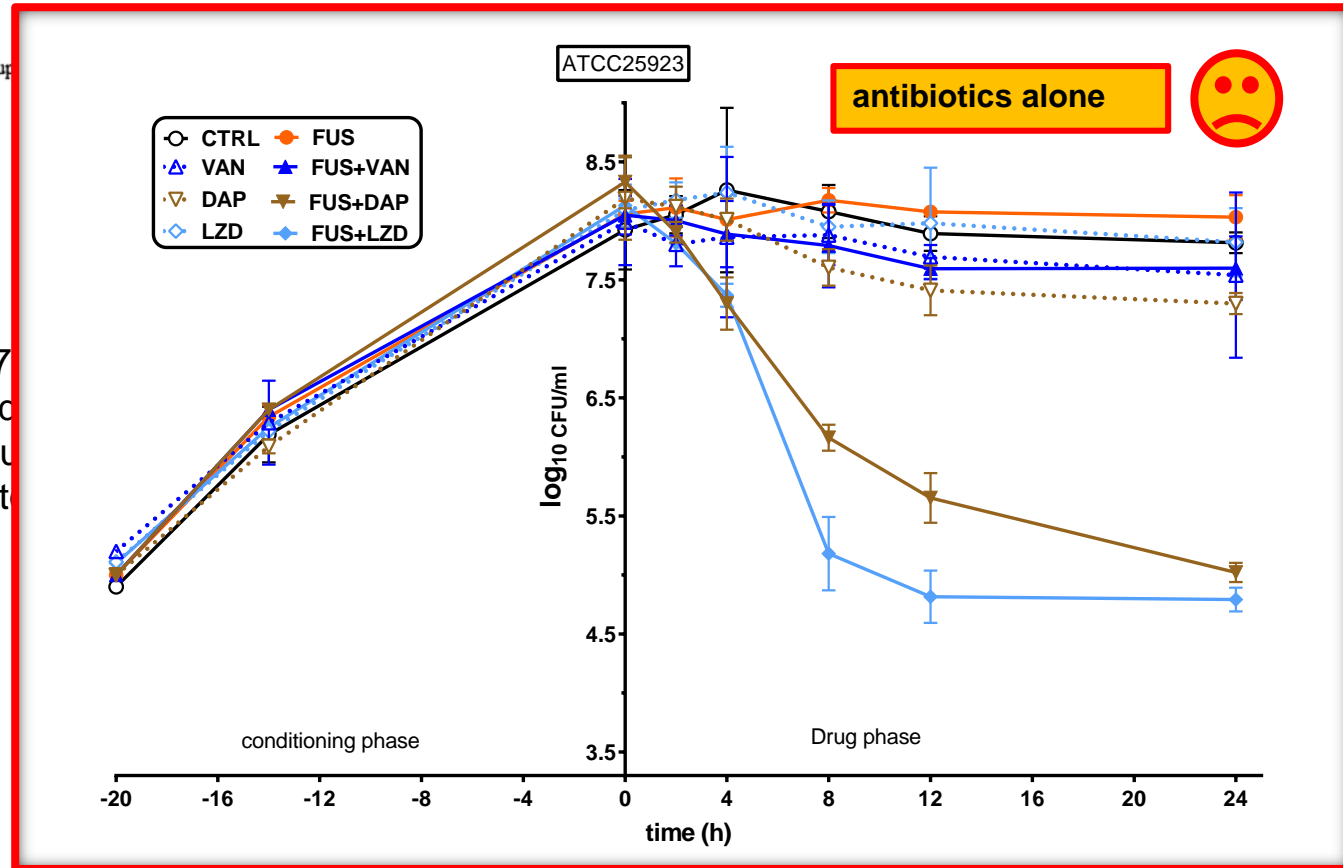

Combining antibiotics in a dynamic model

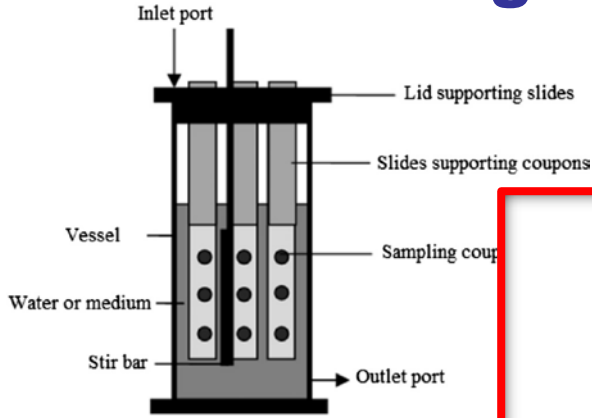

The CDC reactor:

Biofilms are grown on 12.7 mm diameter coupons, suspended in the bulk fluid by eight coupon holders and then exposed to antibiotic concentrations mimicking their human pharmacokinetics

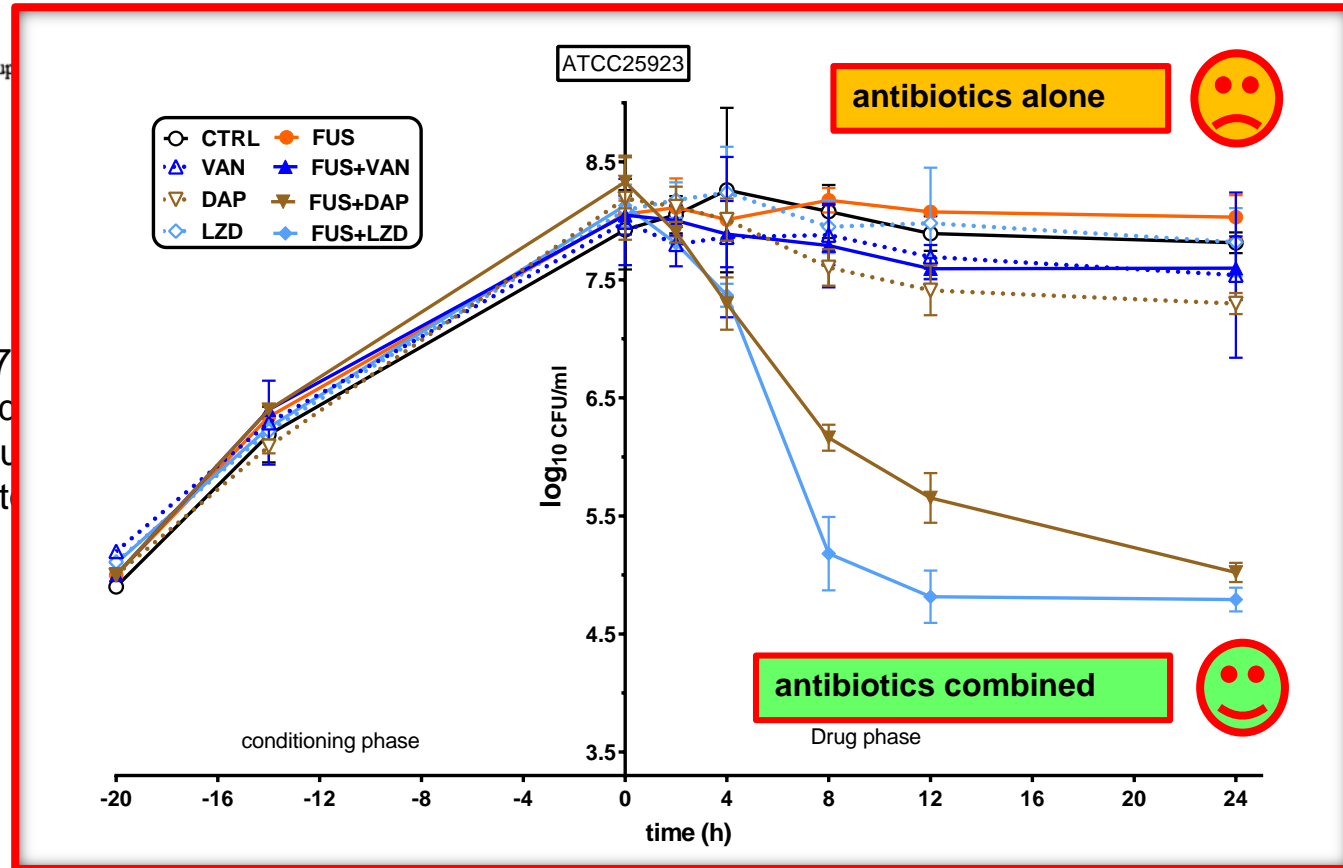

Biofilms: what can you do next ?

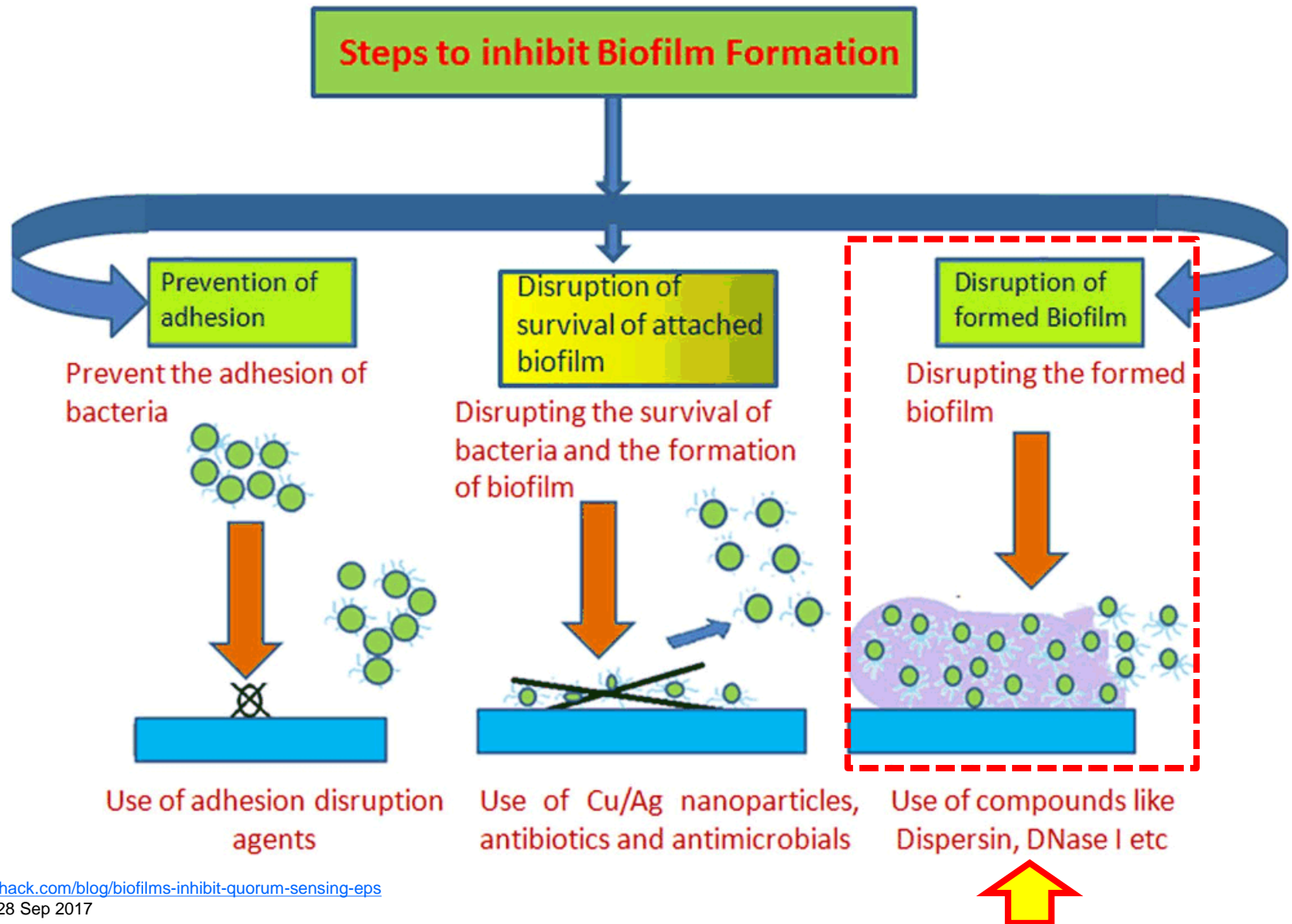

Biofilm matrix: what is it made of ?

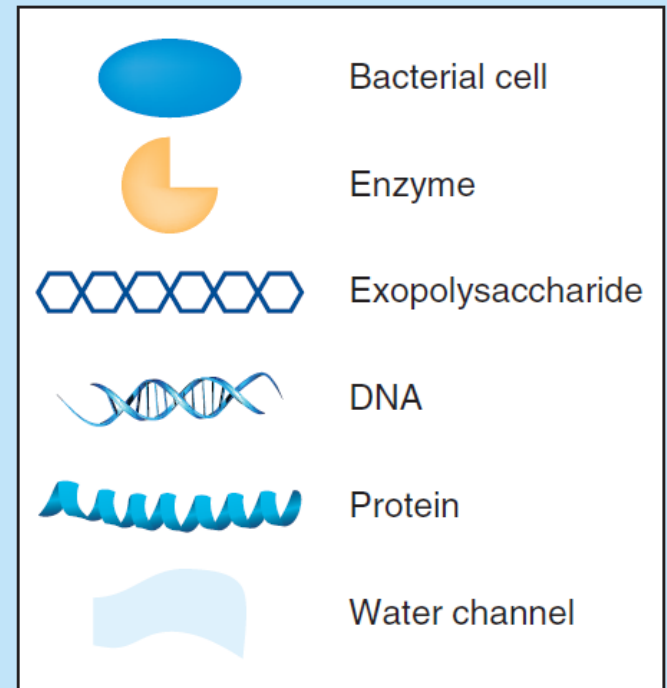
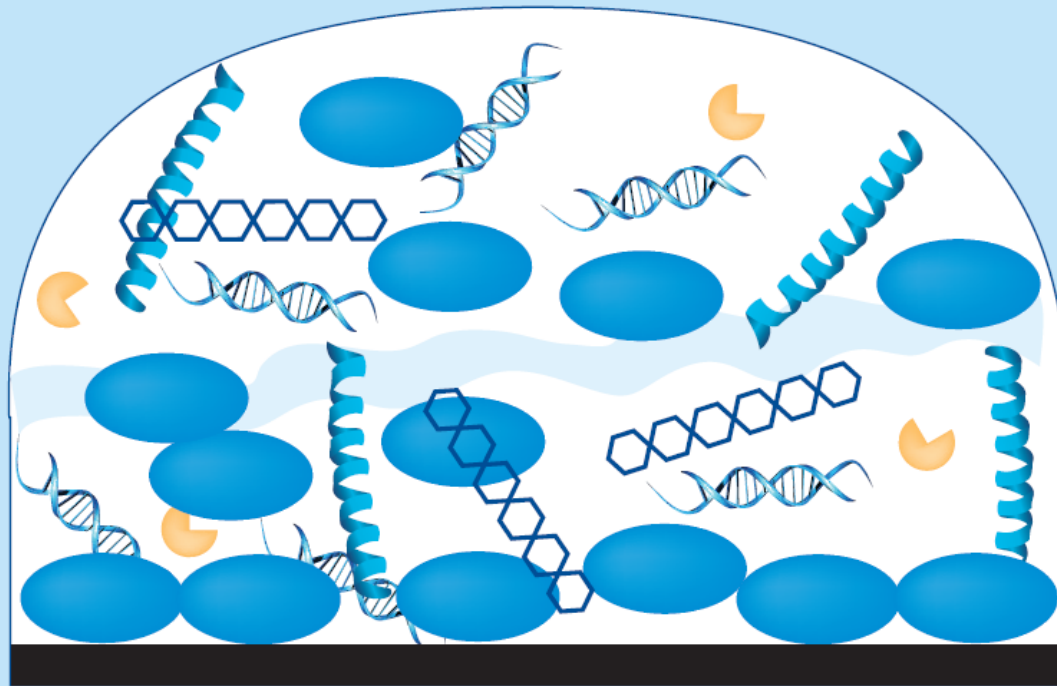

Rabin et al., Future Med. Chem. 2015; 7:493–512

An unanticipated observation !

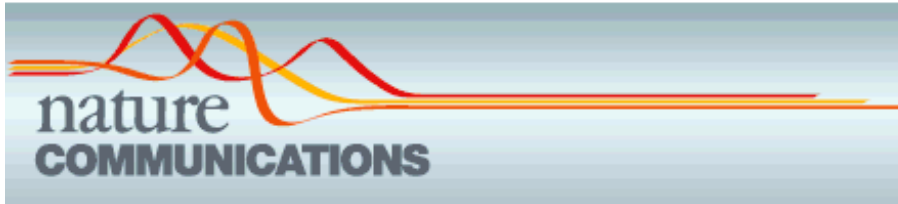

ARTICLE

Received 23 Feb 2016 | Accepted 20 Sep 2016 | Published 3 Nov 2016

DOI: 10.1038/ncomms13286

OPEN

The antifungal caspofungin increases fluoroquinolone activity against *Staphylococcus aureus* biofilms by inhibiting *N*-acetylglucosamine transferase

Wafi Siala¹, Soňa Kucharíková^{2,3}, Annabel Braem⁴, Jef Vleugels⁴, Paul M. Tulkens¹, Marie-Paule Mingeot-Leclercq¹, Patrick Van Dijck^{2,3} & Françoise Van Bambeke¹

<http://www.nature.com/articles/ncomms13286>

Siala *et al.*, Nature Communications 2016; 7:13286 – PMID: [27808087](https://pubmed.ncbi.nlm.nih.gov/27808087/)

Caspofungin increases fluoroquinolone activity *in vitro* and *in vivo*

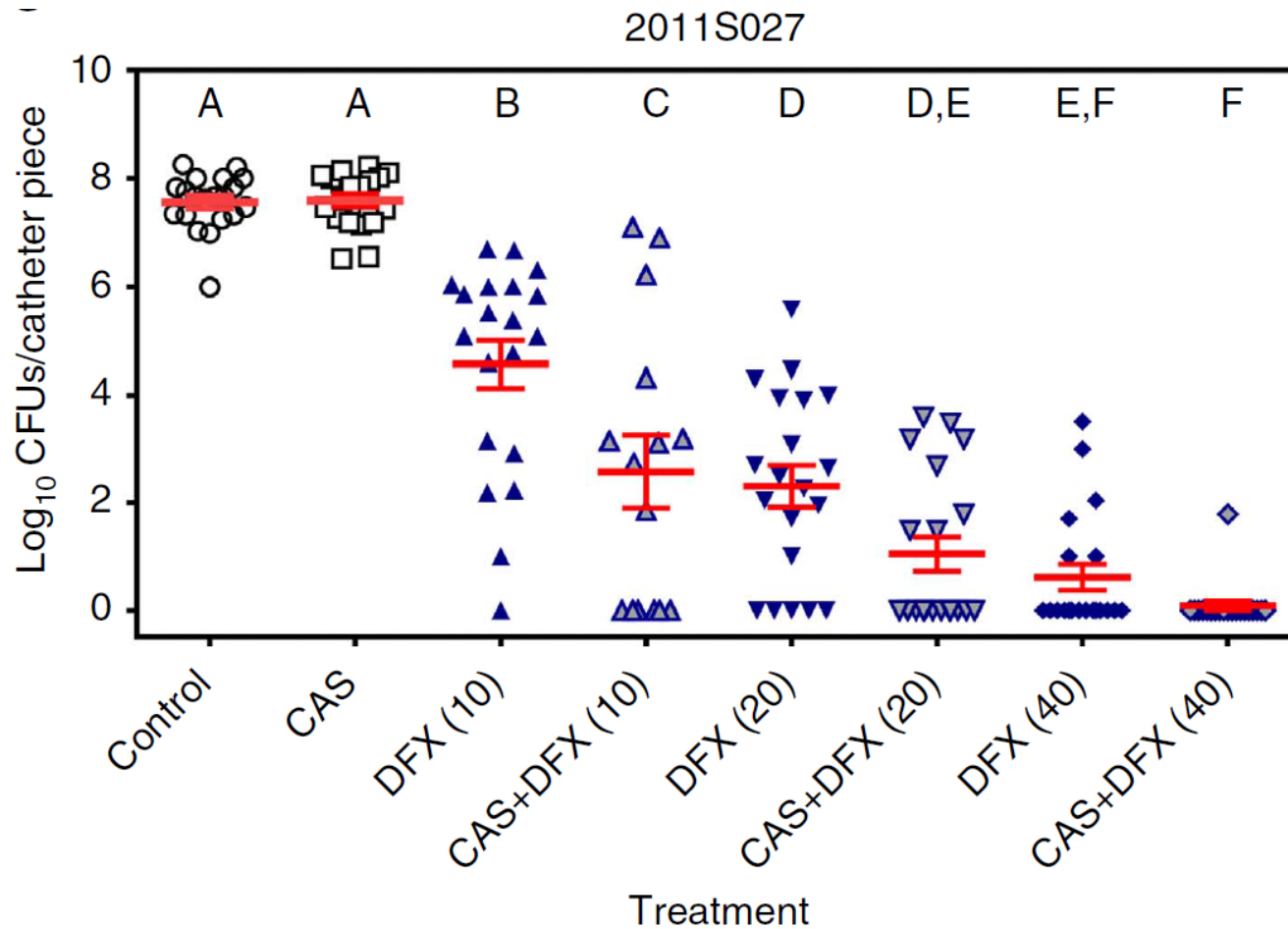

Caspofungin makes fluoroquinolones active at lower concentrations

Caspofungin increases fluoroquinolone penetration

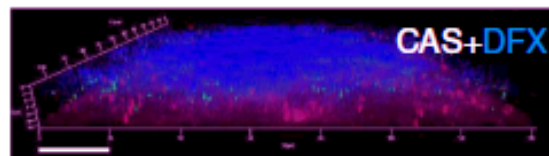
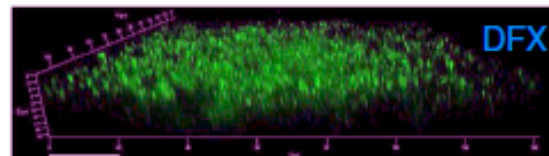
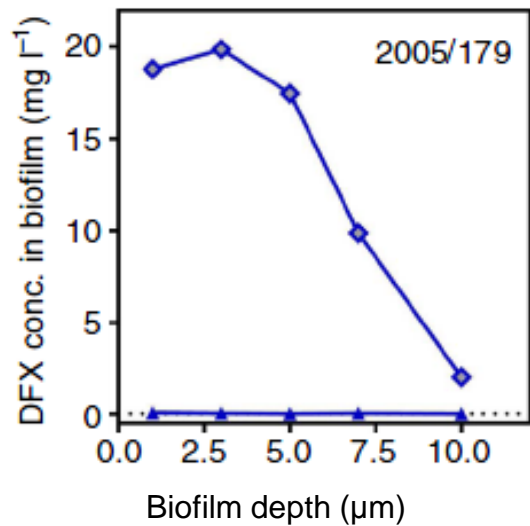
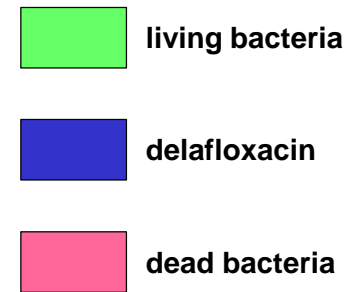
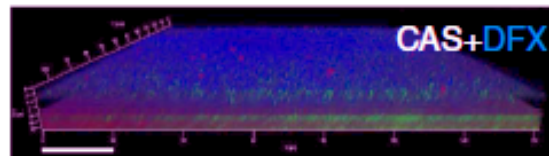
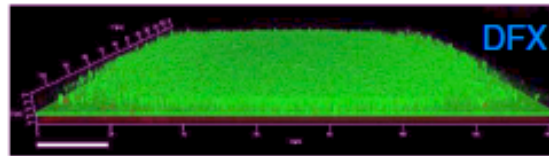
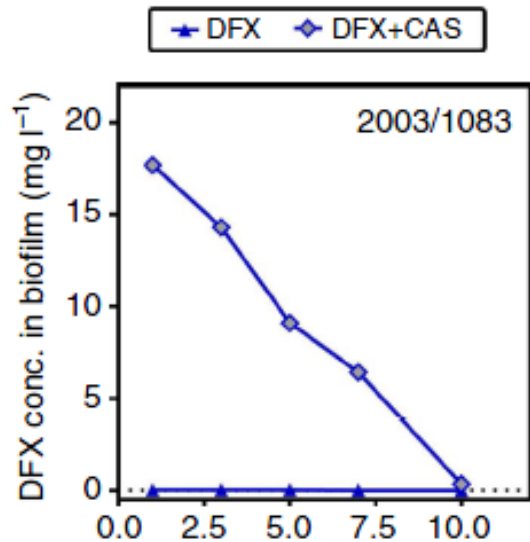

Siala *et al*, Nature Communications 2016; 7:13286 – PMID: [27808087](https://pubmed.ncbi.nlm.nih.gov/27808087/)

Effect of caspofungin on PNAG in biofilm matrix

a) Immunoblot analysis of PNAG purified from biofilms.



b) Determination of N-acetyl-glucosamine (GlcNAc) concentration

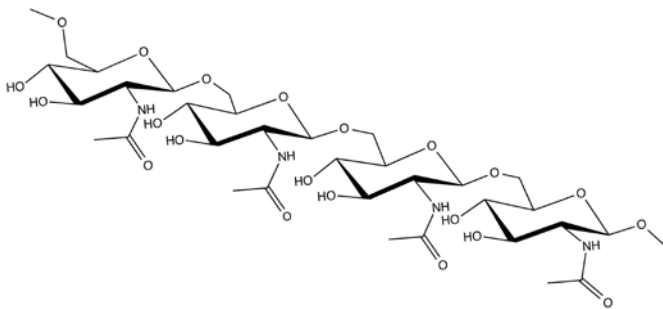

Poly-N-acetylglucosamine (PNAG)

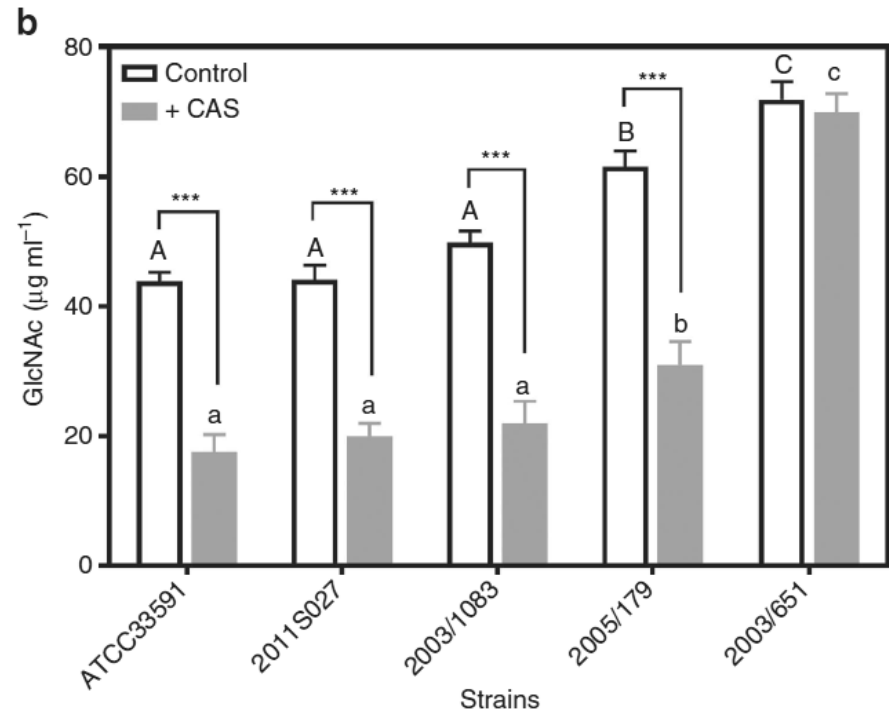
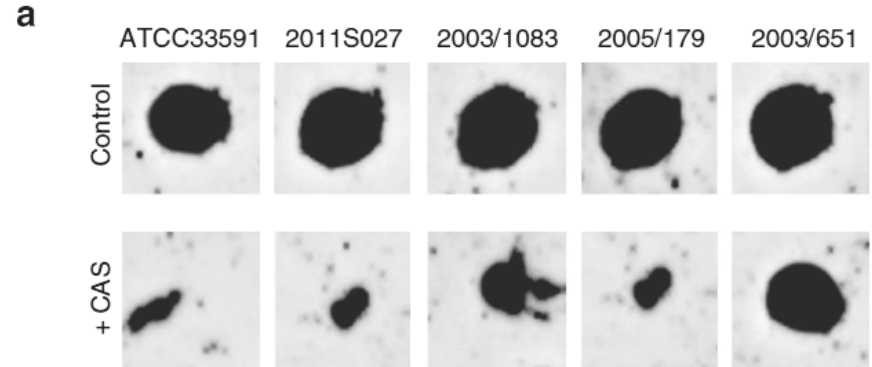

CAS \searrow poly-N-acetylglucosamine content in biofilms