

33ème Congrès National de la Société Tunisienne de
Pathologie Infectieuse (STPI)



La PCR multiplex par la technologie DNA Flow



Dr Mouna Jendoubi
Head of Molecular Biology and Anatomopathology Department
STIES Company



A propos de Vitro

Worldwide company!

Présente sur plus de 40 pays.

We offer quality!

évaluée avec succès par tous les contrôles de qualité externes, garantissant ainsi la qualité de ses produits CE-IVD



Distribution Offices

GRANADA | SEVILLE | MADRID | LISBON | ISTANBUL



<https://www.vitro.bio/Inter/inicio>

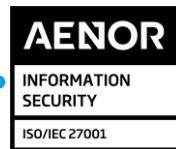



About Vitro

Administration



Contrôle



Reference Lab

Service de référence et R+D
département



Production

chaîne de production,
entrepôt et contrôle qualité
interne,

Software

Service de programmation
et logiciel

Export and Sales

Départements de vente
et d'exportation



DNA Flow Technology

Réactif de PCR

Comporte tout le nécessaire pour la réaction

FORMAT
lyophilisé

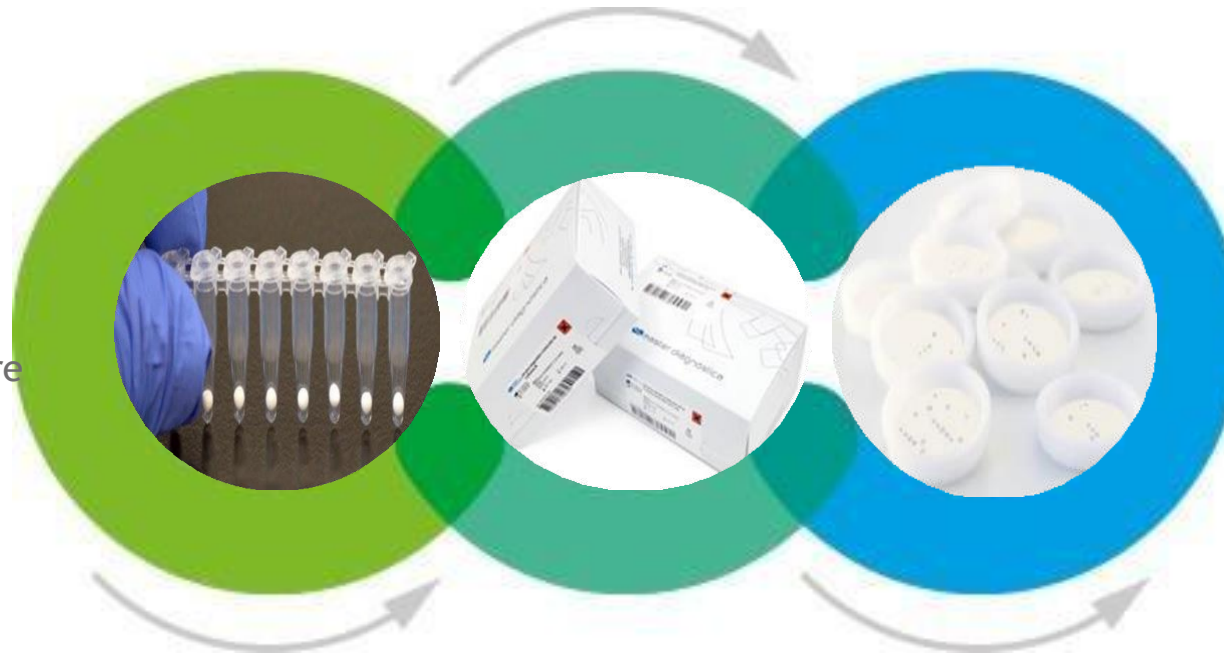

Puces

repérées avec des sondes d'oligonucléotides artificielles

Réactif d'Hybridation

Comporte tous les réactifs enzymatiques et chromogéniques nécessaire

Comment ça fonctionne ?



1 Kits de Diagnostic moléculaire

Basé sur des PCR Multiplex

2 Hybridation active Dans un environnement en 3D

Signal visualisé par une réaction immuno-enzymatique et colorimétrique

Analyse des résultats automatique avec **hybriSoft**

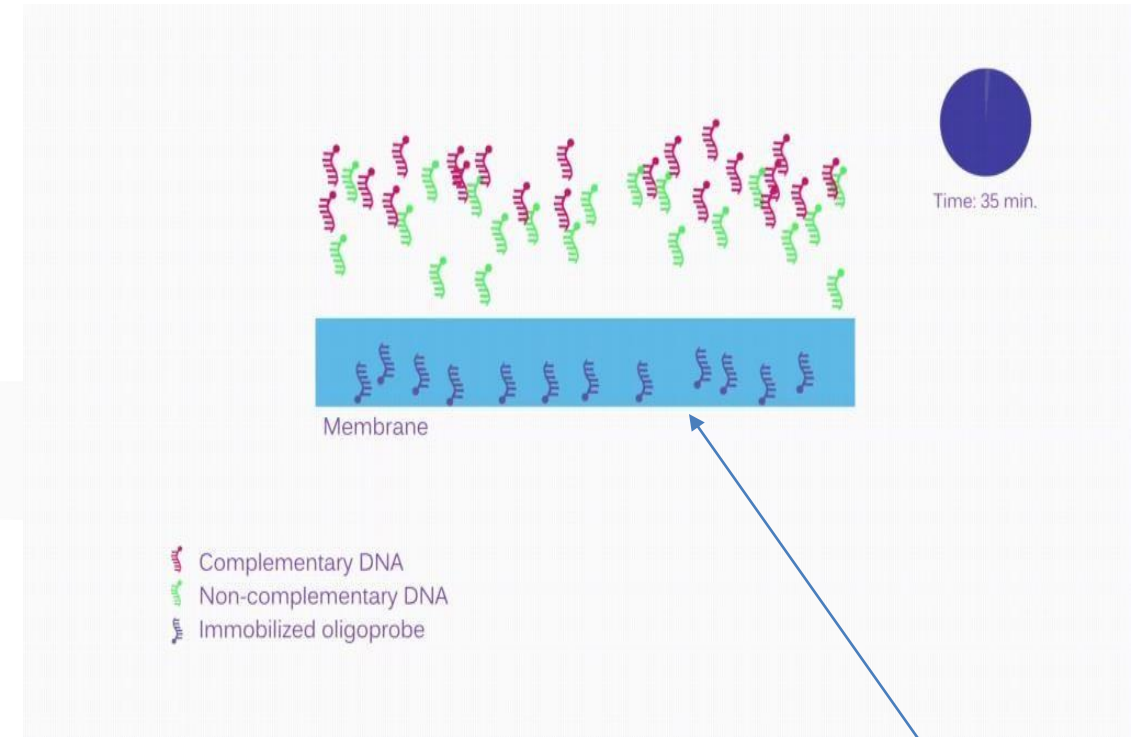

Puce comporte les oligonucléotides pour s'apparier avec les amplicons spécifiques

Les instruments:

DNA
FLOW
technology



MANUAL SYSTEM



AUTOMATIC SYE

3h30



HybriSpot HS12 semi-auto

Systeme d'hybridation semi automatique adapté à la technologie DNA flow avec une option d'assistance pour tous les panels



- ✓ Idéale pour les labo à moyen et à faible débit
- ✓ Economique
- ✓ Solide et compacte
- ✓ Rapide, spécifique pour le diagnostic
- ✓ Équipé par chambre thermostatiques avec pompe à vide
- ✓ 1-12 échantillons par réaction
- ✓ Utilisation simple
- ✓ Analyse automatique des résultats

HybriSpot HS12

Auto Système automatique adapté à la technologie DNA flow



- ✓ Totalement automatisé: amplification, dénaturation et hybridation
- ✓ Décontamination par l'UV
- ✓ Rapide, sensible et spécifique
- ✓ Equipé avec des chambres thermostatiques et des pompes sous vides
- ✓ Amplification de 1 à 12 échantillons
- ✓ Hybridation de 1 à 12 échantillons
- ✓ Utilisation simple
- ✓ Capture automatique des échantillons
- ✓ Analyse automatique des résultats

La Technologie de **DNA** **Flow** Panels

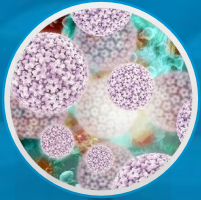

HPV Flow Chip
35 HPV genotypes



AMR Flow Chip
20 gènes de
résistance

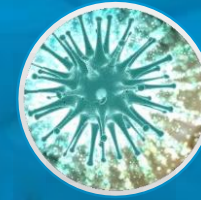

Respiratory Flow Chip
23 agents pathogènes liés
aux infections respiratoires



STD Flow Chip
11 pathogènes

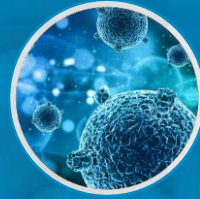

MDR Flow Chip
5 espèces
bactériennes +
56 marqueurs de
résistance

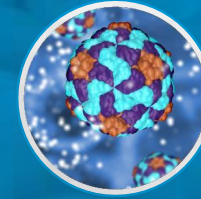

Tick-borne Flow Chip
7 tiques responsables de la
transmission des infections
bactériennes et virales

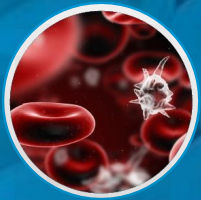

Sepsis Flow Chip
36 pathogènes +
20 gènes de résistance

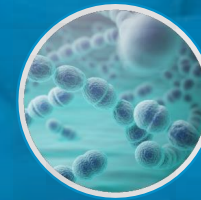

Bacterial CNS Flow Chip
9 bactéries et un
champignons

DNA Flow Technology Panels

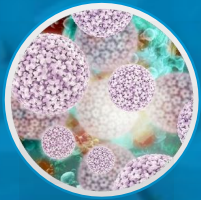

HPV Flow Chip
35 HPV genotypes



AMR Flow Chip 20
gènes de résistance



STD Flow Chip
11 pathogènes

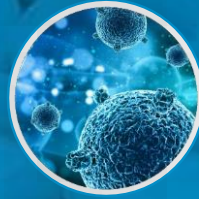

MDR Flow Chip
5 espèces bactériennes
56 gènes de
résistance

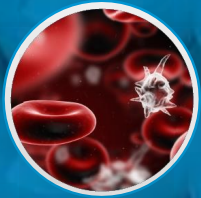

Sepsis Flow Chip
36 pathogènes +
20 gènes de résistance aux
ATB



Sans extraction d'ADN/**Ni purification**



Controles **inclus**



Uracil-DNA **Glycosylase**

Préparation de l'échantillon Cervicale et anale



NOTE: pour les échantillons hémorragiques ajouter un lavage de 400 µl de H₂O*

Préparation des échantillons sur liquide cytologique

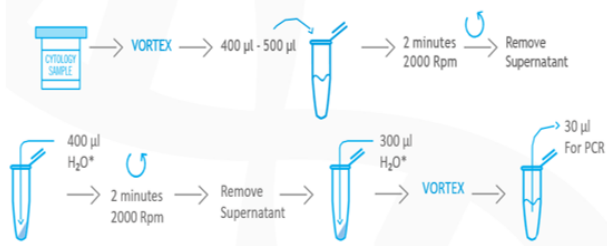

Préparation des échantillons transport medium

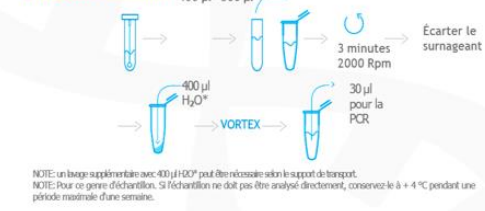

NOTE: un lavage supplémentaire avec 400 µl H₂O* peut être nécessaire selon le support de transport.
NOTE: Pour ce genre d'échantillon, si l'échantillon ne doit pas être analysé directement, conservez-le à +4 °C pendant une période maximale d'une semaine.

Urétrale, cervicale, anal et pharyngé

Échantillons cliniques pour écouvillons secs



NOTE: Pour le proctement, un lavage supplémentaire peut être nécessaire en fonction de la turbidité

Préparation des échantillons Sur tissu paraffiné

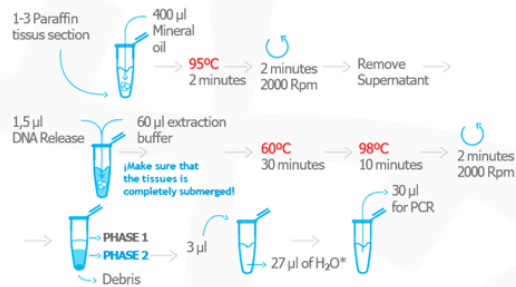

(Make sure that the tissues is completely submerged!)

Préparation des échantillons Urine et endocervicale

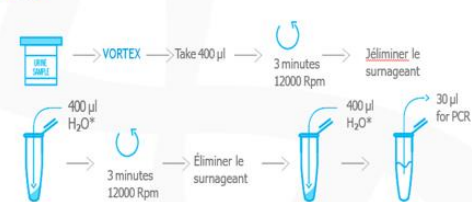

Préparation d'échantillon Sperme

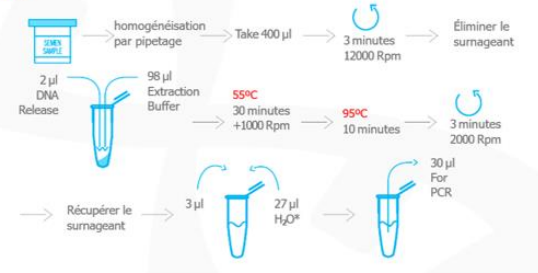

11

Préparation d'échantillon Hémocultures

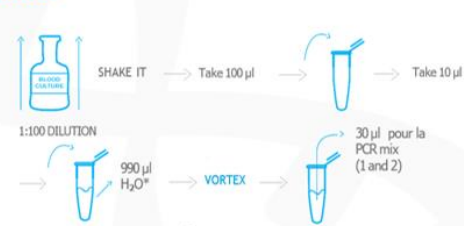

Préparation de l'échantillon Hémocultures hémopédiatrique



Exsudats rectaux

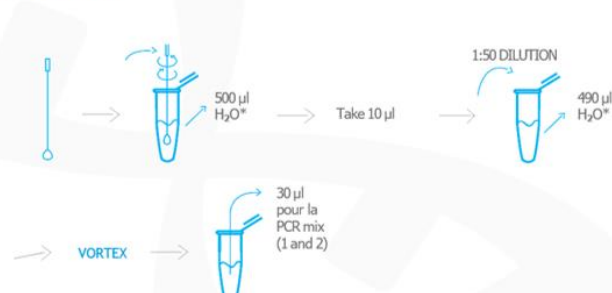

Échantillon: Colonies bactériennes

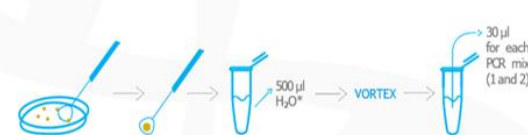

DNA Flow Technology

Panels avec extraction

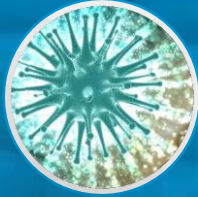

Respiratory Flow Chip
23 agents pathogènes,
impliqués dans les
infections respiratoires

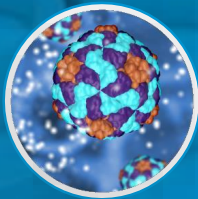

Tick-borne Flow Chip
7 tiques

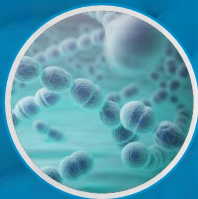

Bacterial CNS Flow Chip
9 bactéries et
1 champignon



Extraction d'ADN/**purification**



Controles **inclus**



Uracil-DNA **Glycosylase**

L'extraction d'ADN

EXTRACTION KITS	EXTRACTION INSTRUMENTS
MagNA Pure LC Total Nucleic Acid Isolation Kit (Roche Diagnostics)	MagNA Pure Compact Instrument. Version 1.1.2 (Roche Diagnostics)
QIAAsymphony Certal Kits (Qiagen)	QIAAsymphony SP (Qiagen)
NucliSENS EasyMAG (Biomerieux)	NucliSENS EasyMAG (Biomerieux)
PureLink Viral RNA/DNA extraction mini kit (Invitrogen)	Manual system

La position des contrôles sur la puce à ADN

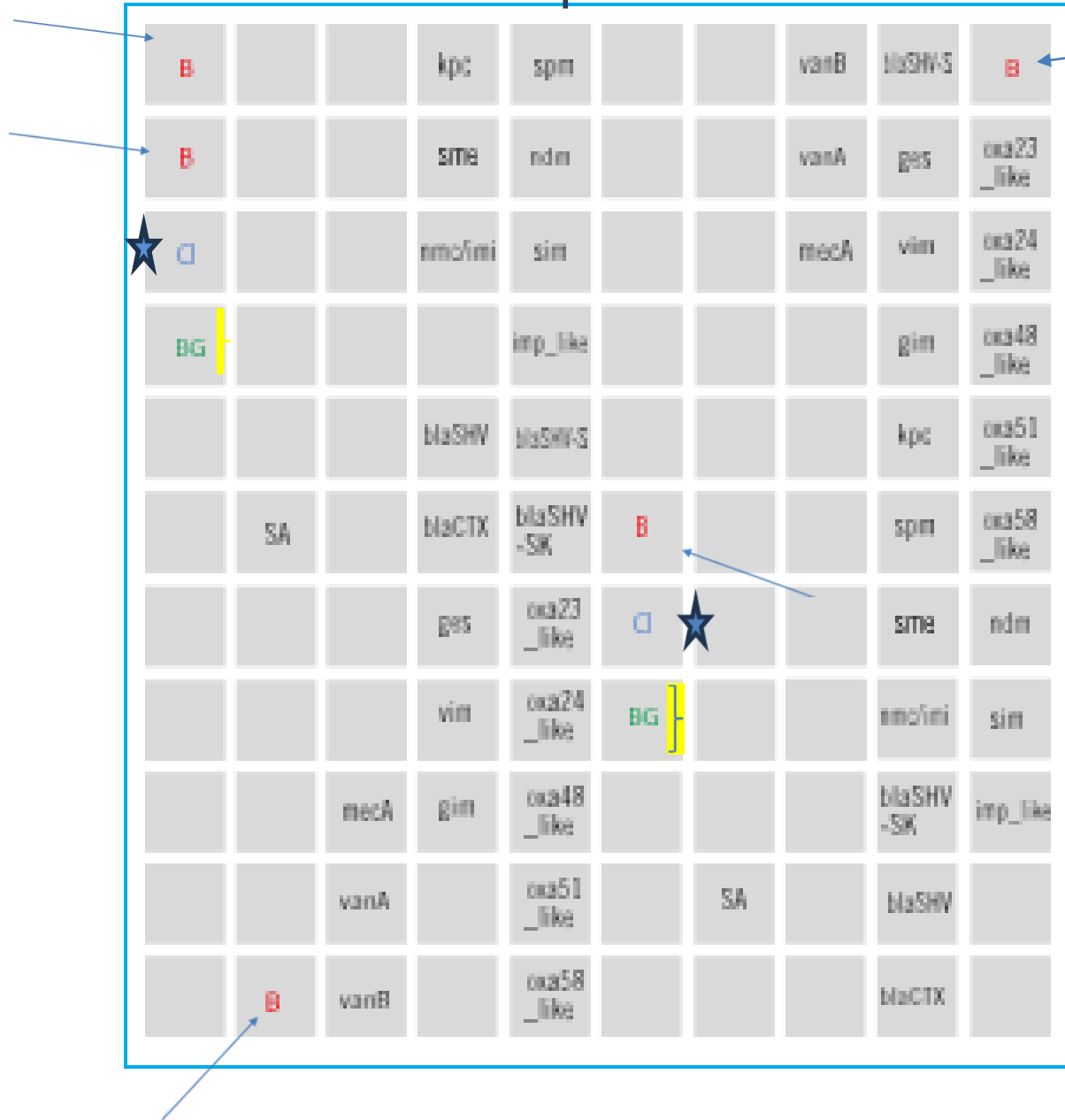

B: 5 contrôles d'hybridation

CI: 2 contrôles d'amplification

BG: 2 Contrôles universel

Logiciel hybriSoft

DNA
FLOW
TECNOLOGY



Logiciel de gestion avancé
prenant en charge les
instruments **hybriSpot**



Developpé par
Vitro S.A



Caractéristiques :

- Gestion des échantillons et de réactifs
- Capture automatique d'images Analyse automatique des tableaux finaux
- Rapports imprimés
- Connexion LIS

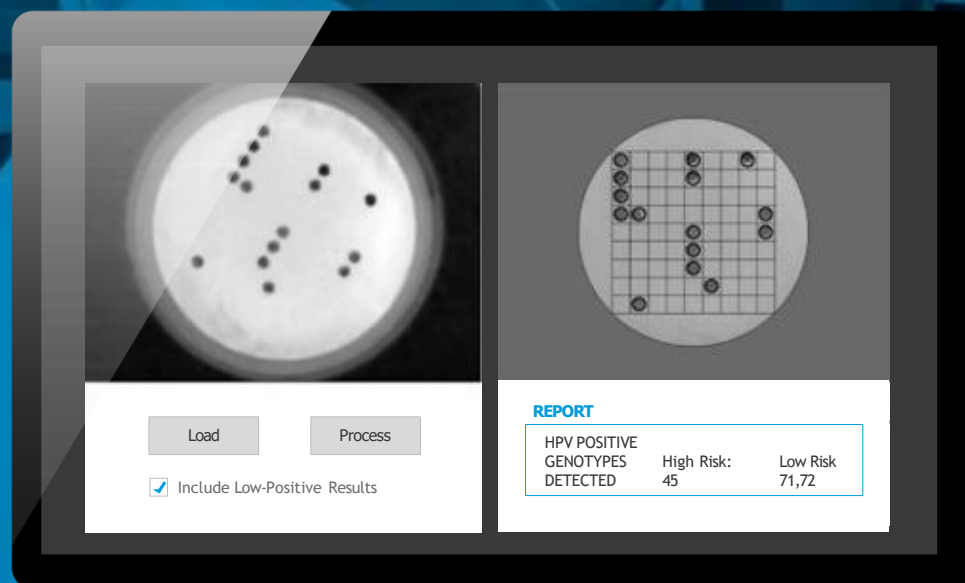

hybriSpot 12
PCR AUTO

Exemple de résultat généré par Hybrisoft



HPV Direct Flow Chip Kit

LOTS

PCR:	HPVP016AL-4	🕒 3/30/2024
Chips:	HPVH0106E	🕒 3/30/2024
Reagent:	HPVH0106E	🕒 3/30/2024

SAMPLE DETAILS

ID SAMPLE: SAMPLESHHT
 ID PATIENT: PATIENT:
 SEX: - BIRTHDATE:

SAMPLE TYPE:

Renseignements cliniques
 AGE:

REPORT

HPV POSITIVE

Positive sample for:

High-Risk:

16*

Low-Risk:

6

The sample is negative for the rest of genotypes included in the HPV direct flow chip test.

(*) Included when marking points manually.

PROTOCOL

Detection and genotyping of HPV viral DNA by PCR and reverse dot blot hybridization:

- High risk genotypes: 16, 18, 26, 31, 33, 35, 39, 45, 51, 52, 53, 56, 58, 59, 66, 68, 73, 82.

- Low risk genotypes: 6, 11, 40, 42, 43, 44/55, 54, 61, 62/81, 67, 69, 70, 71, 72, 84.

Sample preparation/DNA purification

Add cell suspension/purified DNA for PCR amplification:

- PCR protocol (standard) HPV Direct Flow Chip: 1x 25°C 10 min, 1x 94°C 3min; 15x94-42-72°C (30"-30"-30"), 35x 94-60-72°C (30"-30"-30"), 1x 72°C 5 min.

- PCR protocol (lyophilized) HPV Direct Flow Chip: 1x 25°C 10 min, 1x 94°C 3min; 15x94-47-72°C (30"-30"-30"), 35x 94-65-72°C (30"-30"-30"), 1x 72°C 5 min.

REVERSE-DOT BLOT protocol:

- Hybridization of the biotinilated PCR products to the HPV CHIP.

- Post-hybridization washes.

- Streptavidin-Alkaline Phosphatase incubation.

- NBT-BCIP development.

Automatic analysis of results

résultat

protocole



HPV Direct Flow Chip Kit

LOTS

PCR:	HPVP016AL-4	🕒 3/30/2024
Chips:	HPVH0106E	🕒 3/30/2024
Reagent:	HPVH0106E	🕒 3/30/2024

SAMPLE DETAILS

ID SAMPLE: SAMPLESHHT

SAMPLE TYPE:

ID PATIENT:

PATIENT:

SEX: -

BIRTHDATE:

AGE:

REPORT

B	33	58	42	71	16	52	B	
B	35	59	43	72	18	53	6	69
C	39	66	44/55		26	56	11	70
U	45	68	54	84	31	58	40	71
16	51	73	61	B	33	59	44/55	72
18	52	82	62/81	C	35	66	54	
26	53	6	67	U	39	68	61	84
31	56	11	69	42	45	73	62/81	
	B	40	70	43	51	82	67	

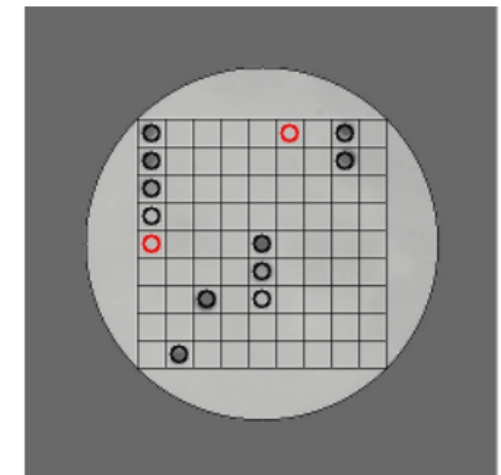

- Spot B: Hybridization control (5 signals to orientate the CHIP)

- Spot C: Internal DNA control (Genomic human DNA probe)

- Spot U: HPV Universal probe

- Spot #: Genotype specific probes

All the spots are printed in duplicate.

Puce du patient avec le profil infectieux

ANALYSIS INFORMATION

Threshold: 6

Sepsis Flow Chip Kit

LOTS

PCR:	SEPP015L-2	🕒 1/31/2024
Chips:	SEPH0107LF	🕒 9/30/2023
Reagent:	SEPH0107LF	🕒 9/30/2023

SAMPLE DETAILS

ID SAMPLE:	SAMPLE3	SAMPLE TYPE:	
ID PATIENT:		PATIENT:	
SEX:	-	BIRTHDATE:	
		AGE:	

REPORT

SEP POSITIVE

SAMPLE POSITIVE FOR:

PATHOGENS:

Klebsiella pneumoniae

RESISTANCE GENES:

Methicillin resistance gene (mecA), Extended-spectrum β -lactamase CTX-M, Carbapenemase NDM, Carbapenemase OXA48_like
 Note: Absence of human control DNA.

The sample is negative for the rest of pathogens and antibiotic resistance included in the SEPSIS flow chip test.

PROTOCOL

Detection of a panel of bacteria, fungi, and antibiotic resistance markers by multiplex-PCR and Automatic Reverse Dot Blot that includes:

- Gram positive bacteria: Coagulase negative Staphylococcus, Staphylococcus aureus, Enterococcus spp., Streptococcus spp., Streptococcus pneumoniae, Streptococcus agalactiae, Listeria monocytogenes.
- Gram negative bacteria: Pseudomonas aeruginosa, Acinetobacter baumannii, Stenotrophomonas maltophilia, Escherichia coli, Klebsiella pneumoniae, Serratia marcescens, Enterobacteriaceae, Proteus spp., Morganella morganii, Neisseria meningitidis
- Fungi: Candida spp., C.albicans
- Resistance markers: mecA, vanA, vanB, blaSHV, blaCTX-M, KPC, SME, NMC-IMI, GES, VIM, GIM, SPM, NDM, SIM, IMP, OXA23, OXA24, OXA48, OXA51, OXA58.
- Sample preparation/DNA purification:
 - Add suspension of DNA (prepared according manufacturer's instructions) for PCR amplification
 - PCR protocol: 1x 25° 10 min; 1x 94° 5 min; 40x (94° 30 s-55° 45 s-72° 60 s); 1x 72° 7 min.
 - REVERSE-DOT BLOT protocol:
 - Hybridization of the biotinylated PCR products to the Sepsis CHIP, Post-hybridization washes, Streptavidin-Alkaline Phosphatase incubation, NBT-BCIP development and Automatic analysis of results

ANTIBIOTIC RESISTANCE PROFILE

Possible resistance to: All betalactams, included carbapenems, and aztreonam, except to ceftaroline, and ceftobiprole. Penicillins, and 1st, 2nd and 3rd generation of cephalosporins. Penicillins, carbapenems, and 1st, 2nd and 3rd generation of cephalosporins. Penicillins, carbapenems, and 1st generation of cephalosporins (Note: It

Sepsis Flow Chip Kit

LOTS

PCR:	SEPP015L-2	🕒 1/31/2024
Chips:	SEPH0107LF	🕒 9/30/2023
Reagent:	SEPH0107LF	🕒 9/30/2023

SAMPLE DETAILS

ID SAMPLE:	SAMPLE3	SAMPLE TYPE:	
ID PATIENT:		PATIENT:	
SEX:	-	BIRTHDATE:	
		AGE:	

REPORT

B		LIS	kpc	spm		ECOLI	vanB		B
B	ABAU	ENTEROC	sme	ndm		ENTEROB	vanA	ges	oxa23
CI	SMAR/KL EB	PAER	nmc/ imi	sim			mecA	vim	oxa24
BG	SAGAL	KLEB	SPVOG	imp	SMALTO	CALB		gim	oxa48
	STAPHYL	STREP	blaSHV		CAND		PROT/M OR	kpc	oxa51
SPNEU	SA	NEIS	blaCTX		B	ABAU	LIS	spm	oxa58
	ECOLI	PROT/M OR	ges	oxa23	CI	SMAR/KL EB	ENTEROC	sme	ndm
SMALTO	ENTEROB		vim	oxa24	BG	SAGAL	PAER	nmc/ imi	sim
CAND		mecA	gim	oxa48		STAPHYL	KLEB	SPVOG	imp
	CALB	vanA		oxa51	SPNEU	SA	STREP	blaSHV	
	B	vanB		oxa58			NEIS	blaCTX	

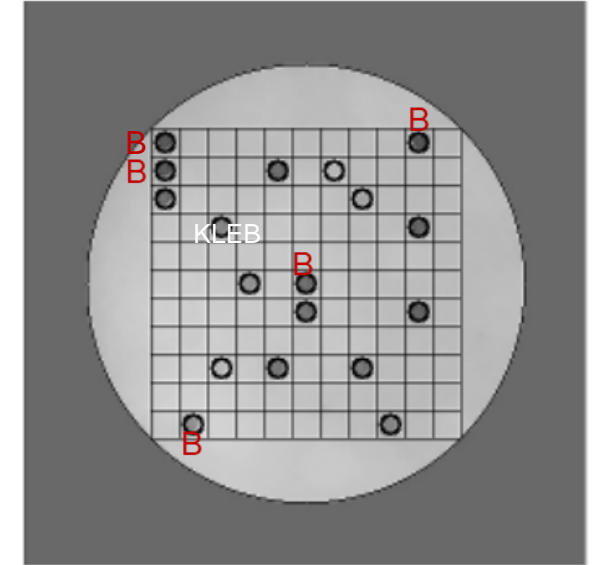

- Spot B: Hybridization control (5 signals to orientate the CHIP)
 - Spot CI: Amplification control
 - Spot BG: DNA Control (Genomic human DNA probe)
 - Spot #: Pathogen specific probes
- All the spots are printed in duplicate.

Exemple de lecture de chip

REPORT

B		LIS	kpc	spm		ECOLI	vanB		B
B	ABAU	ENTEROC	sme	ndm		ENTEROB	vanA	ges	oxa23
CI	SMAR/KLEB	PAER	nmc/imi	sim			mecA	vim	oxa24
BG	SAGAL	KLEB	SPYOG	imp	SMALTO	CALB		gim	oxa48
	STAPHYL	STREP	blaSHV		CAND		PROT/MOR	kpc	oxa51
SPNEU	SA	NEIS	blaCTX		B	ABAU	LIS	spm	oxa58
	ECOLI	PROT/MOR	ges	oxa23	CI	SMAR/KLEB	ENTEROC	sme	ndm
SMALTO	ENTEROB		vim	oxa24	BG	SAGAL	PAER	nmc/imi	sim
CAND		mecA	gim	oxa48		STAPHYL	KLEB	SPYOG	imp
	CALB	vanA		oxa51	SPNEU	SA	STREP	blaSHV	
	B	vanB		oxa58			NEIS	blaCTX	

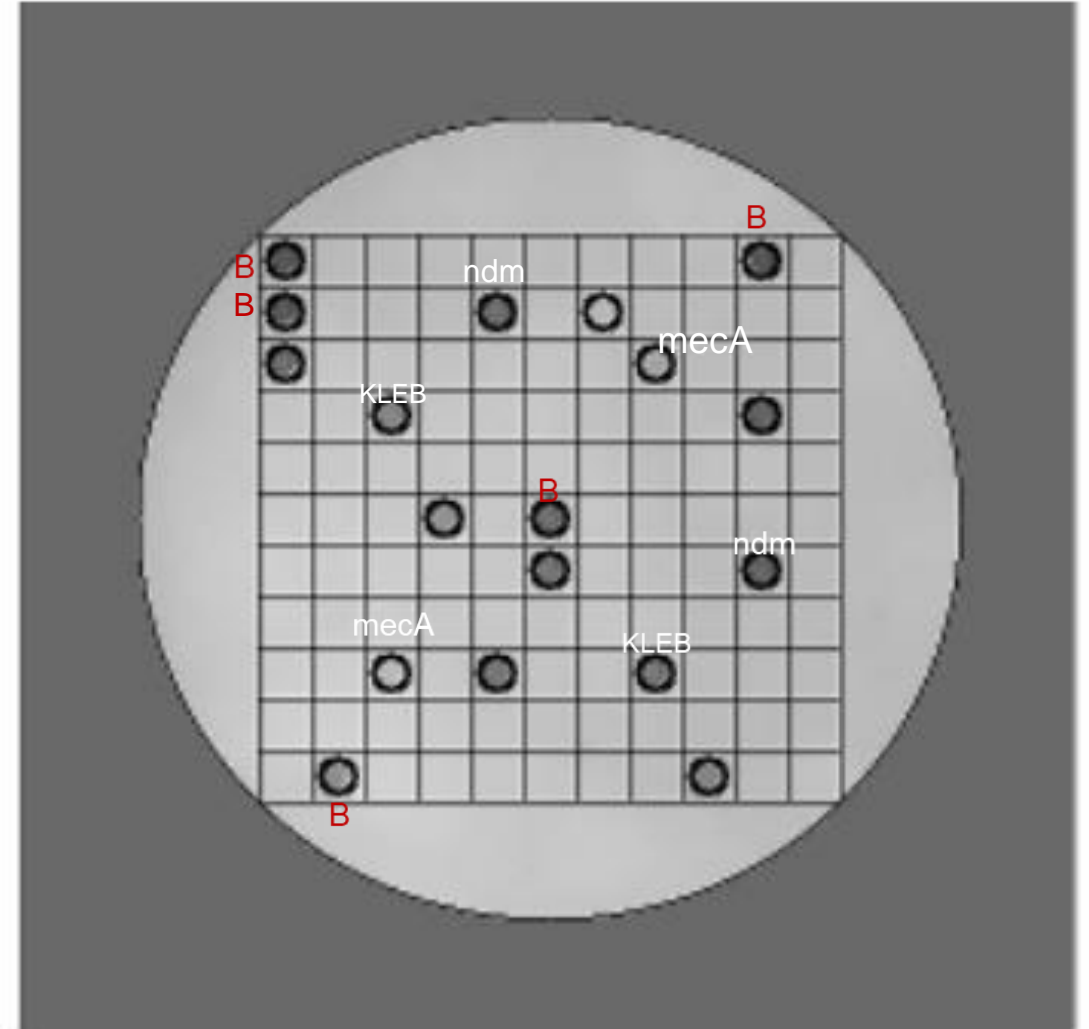

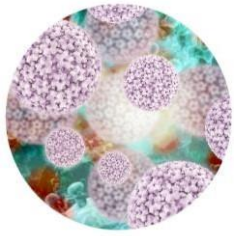

HPV Flow Chip HPV Direct Flow Chip Kit



B	33	58	42	71	16	52	B	
B	35	59	43	72	18	53	6	69
C	39	66	44/55		26	56	11	70
U	45	68	54	84	31	58	40	71
16	51	73	61	B	33	59	44/55	72
18	52	82	62/81	C	35	66	54	
26	53	6	67	U	39	68	61	84
31	56	11	69	42	45	73	62/81	
	B	40	70	43	51	82	67	



Validation scientifique et Clinique

- OMS LabNet (100% de compétence)
- Publications Scientifiques





Merci

INTERET PRATIQUE DE LA PCR MULTIPLEX

« HYBRISPOT HS12 auto »

Pr Selim Asli

I- Les Infections sexuellement transmissibles

- ✓ HPV
- ✓ STD

II- Identification des bactéries hautement pathogène et des gènes de résistance

- ✓ AMR
- ✓ MDR
- ✓ Sepsis

III- Les infections transmises par les tiques et Méningites

- ✓ Tick-born
- ✓ Bacterial CNS

HPV Direct Flow Chip Kit

Génotypage
De 35 types d'HPV

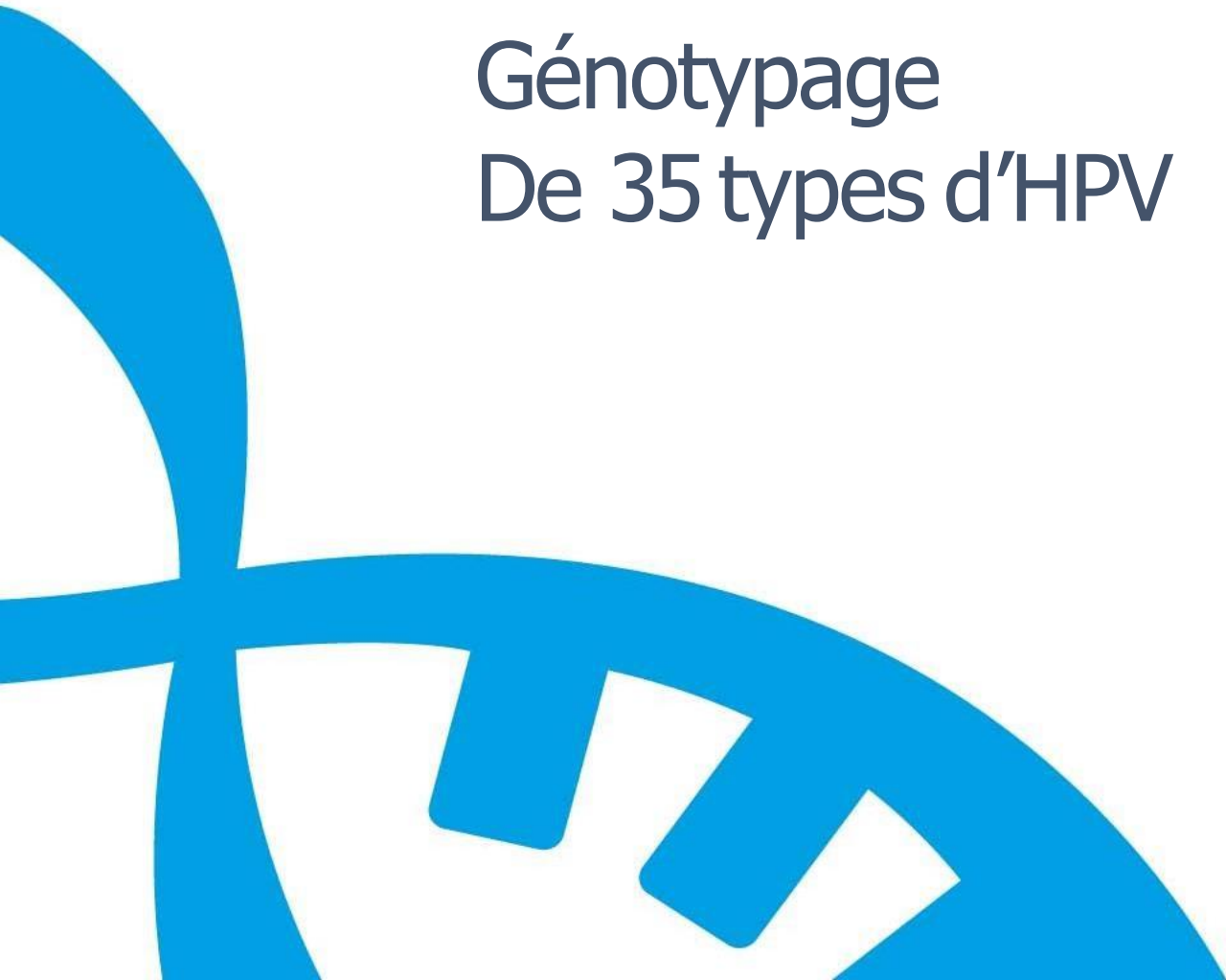
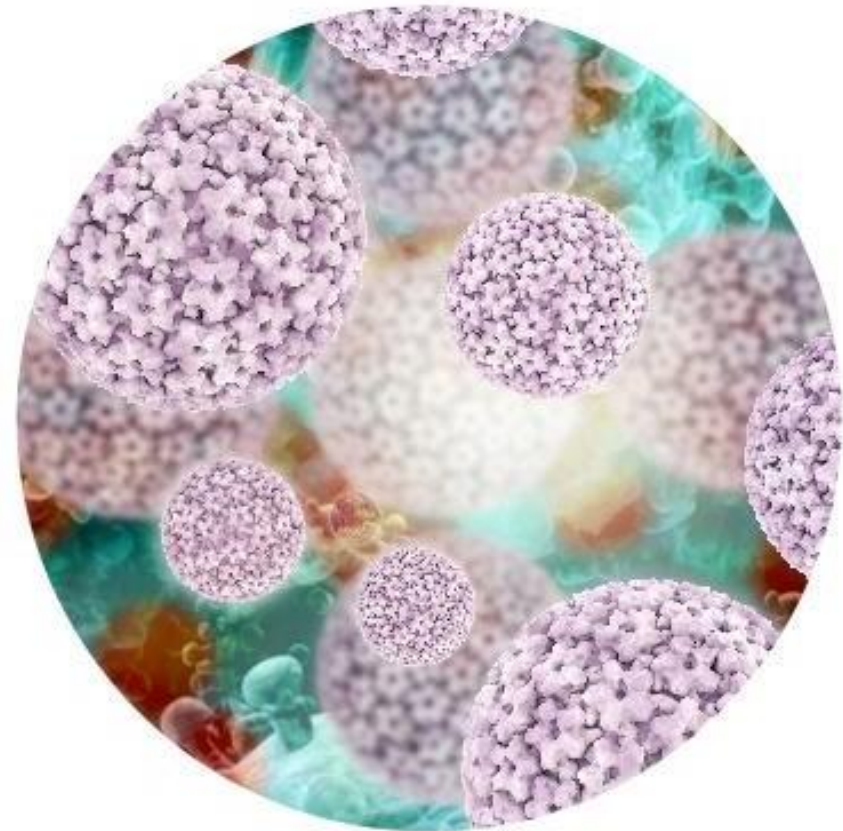

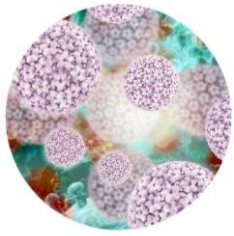

HPV Flow Chip HPV Direct Flow Chip Kit

Détection Simultanée et génotypage de 35 HPV



B	33	58	42	71	16	52	B	
B	35	59	43	72	18	53	6	69
C	39	66	44/55		26	56	11	70
U	45	68	54	84	31	58	40	71
16	51	73	61	B	33	59	44/55	72
18	52	82	62/81	C	35	66	54	
26	53	6	67	U	39	68	61	84
31	56	11	69	42	45	73	62/81	
	B	40	70	43	51	82	67	

Haut-risque:

16, 18, 26, 31, 33, 35, 39, 45, 51, 52, 53, 56, 58, 59, 66, 68, 73, 82.

Bas-risque:

6, 11, 40, 42, 43, 44, 54, 55, 61, 62, 67, 69, 70, 71, 72, 81, 84.

- ✓ Amplification de l'ORF L1 of
- ✓ Contrôle B d'hybridation
- ✓ Contrôle C d'amplification
- ✓ Contrôle universel U (HPV specific) Présence du HPV DNA

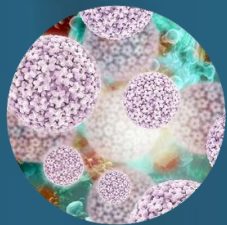

HPV Flow Chip HPV Direct Flow Chip Kit

Broad range of validated sample types

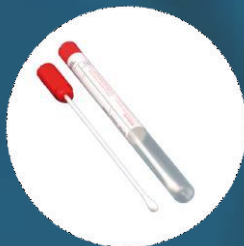

Écouvillons

Cervicale
Et anale



Liquid-based cytology

Thinprep(Hologic)

CellPrep (Biodyne)

Superpath (Becton
Dickinson)

CY-PRER™ Pap Test
(FJORD Diagnostics)

Novaprep (Novacyt)

HURO PATH Cell-Preserve
Solution (Celtrazone)



Tissu
Paraffiné



VEIL

HPV Direct Flow Chip Kit

LOTS

PCR:	HPVP016AL-4	🕒 3/30/2024
Chips:	HPVH0106E	🕒 3/30/2024
Reagent:	HPVH0106E	🕒 3/30/2024

SAMPLE DETAILS

ID SAMPLE:	SAMPLE4HHT	SAMPLE TYPE:	
ID PATIENT:	PATIENT:		
SEX:	-	BIRTHDATE:	AGE:

REPORT

HPV POSITIVE

Positive sample for:

High-Risk:

53*

Low-Risk:

6

Note: Insufficient Material.

The sample is negative for the rest of genotypes included in the HPV direct flow chip test.

(*) Included when marking points manually.

PROTOCOL

Detection and genotyping of HPV viral DNA by PCR and reverse dot blot hybridization:

- High risk genotypes: 16, 18, 26, 31, 33, 35, 39, 45, 51, 52, 53, 56, 58, 59, 66, 68, 73, 82.

- Low risk genotypes: 6, 11, 40, 42, 43, 44/55, 54, 61, 62/81, 67, 69, 70, 71, 72, 84.

Sample preparation/DNA purification

Add cell suspension/purified DNA for PCR amplification:

- PCR protocol (standard) HPV Direct Flow Chip: 1x 25°C 10 min, 1x 94°C 3min; 15x94-42-72°C (30"-30"-30"), 35x 94-60-72°C (30"-30"-30"), 1x 72°C 5 min.

- PCR protocol (lyophilized) HPV Direct Flow Chip: 1x 25°C 10 min, 1x 94°C 3min; 15x94-47-72°C (30"-30"-30"), 35x 94-65-72°C (30"-30"-30"), 1x 72°C 5 min.

REVERSE-DOT BLOT protocol:

- Hybridization of the biotinylated PCR products to the HPV CHIP.

- Post-hybridization washes.

- Streptavidin-Alkaline Phosphatase incubation.

- NBT-BCIP development.

Automatic analysis of results

HPV Direct Flow Chip Kit

LOTS

PCR:	HPVP016AL-4	🕒 3/30/2024
Chips:	HPVH0106E	🕒 3/30/2024
Reagent:	HPVH0106E	🕒 3/30/2024

SAMPLE DETAILS

ID SAMPLE:	SAMPLE4HHT	SAMPLE TYPE:	
ID PATIENT:	PATIENT:		
SEX:	-	BIRTHDATE:	AGE:

REPORT

B	33	58	42	71	16	52	B	
B	35	59	43	72	18	53	6	69
C	39	66	44/55		26	56	11	70
U	45	68	54	84	31	58	40	71
16	51	73	61	B	33	59	44/55	72
18	52	82	62/81	C	35	66	54	
26	53	6	67	U	39	68	61	84
31	56	11	69	42	45	73	62/81	
	B	40	70	43	51	82	67	

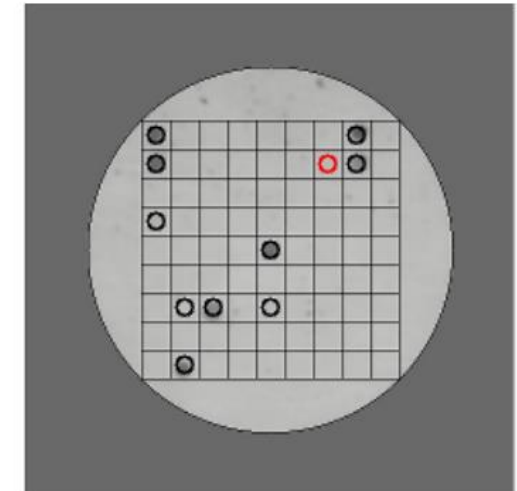

- Spot B: Hybridization control (5 signals to orientate the CHIP)

- Spot C: Internal DNA control (Genomic human DNA probe)

- Spot U: HPV Universal probe

- Spot #: Genotype specific probes

All the spots are printed in duplicate.

Exemple de Trouble shooting



HPV Direct Flow Chip Kit

LOTS

PCR:

Chips:

Reagent:

SAMPLE DETAILS

ID SAMPLE: nafissataessaie

SAMPLE TYPE:

ID PATIENT: PATIENT:

SEX: - BIRTHDATE:

AGE:

REPORT

BLANK

Inappropriate material.
Insufficient Material.
PCR inhibited.



- ✓ Matériel inapproprié
- ✓ Materiel insuffisant
- ✓ PCR inhibée

PROTOCOL

Detection and genotyping of HPV viral DNA by PCR and reverse dot blot hybridization:

- High risk genotypes: 16, 18, 26, 31, 33, 35, 39, 45, 51, 52, 53, 56, 58, 59, 66, 68, 73, 82.
- Low risk genotypes: 6, 11, 40, 42, 43, 44/55, 54, 61, 62/81, 67, 69, 70, 71, 72, 84.

Sample preparation/DNA purification

Add cell suspension/purified DNA for PCR amplification:

- PCR protocol (standard) HPV Direct Flow Chip: 1x 25°C 10 min, 1x 94°C 3min; 15x94-42-72°C (30"-30"-30"), 35x 94-60-72°C (30"-30"-30"), 1x 72°C 5 min.
- PCR protocol (lyophilized) HPV Direct Flow Chip: 1x 25°C 10 min, 1x 94°C 3min; 15x94-47-72°C (30"-30"-30"), 35x 94-65-72°C (30"-30"-30"), 1x 72°C 5 min.

REVERSE-DOT BLOT protocol:

- Hybridization of the biotinilated PCR products to the HPV CHIP.
- Post-hybridization washes.
- Streptavidin-Alkaline Phosphatase incubation.
- NBT-BCIP development.

Automatic analysis of results



HPV Direct Flow Chip Kit

LOTS

PCR:

Chips:

Reagent:

SAMPLE DETAILS

ID SAMPLE: nafissataessaie

SAMPLE TYPE:

ID PATIENT: PATIENT:

SEX: - BIRTHDATE:

AGE:

REPORT

B	33	58	42	71	16	52	B	
B	35	59	43	72	18	53	6	69
C	39	66	44/55		26	56	11	70
U	45	68	54	84	31	58	40	71
16	51	73	61	B	33	59	44/55	72
18	52	82	62/81	C	35	66	54	
26	53	6	67	U	39	68	61	84
31	56	11	69	42	45	73	62/81	
	B	40	70	43	51	82	67	

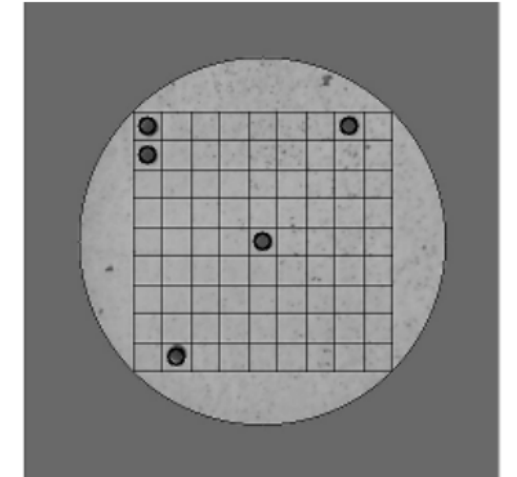

- Spot B: Hybridization control (5 signals to orientate the CHIP)
 - Spot C: Internal DNA control (Genomic human DNA probe)
 - Spot U: HPV Universal probe
 - Spot #: Genotype specific probes
- All the spots are printed in duplicate.

ANALYSIS INFORMATION



which performance requirements should be required and were realistic. A higher requirement for HPV16 and HPV18 was considered essential because of the pivotal role of these HPV types in causing cervical cancer.

RESULTS

Validation of the HPV proficiency panel. The results from the initial panel validation at the GRL Sweden and at DKFZ included the qualitative characterization of HPV and human genomic DNAs. Both of these laboratories used Luminex-based assays with modified GP5+/6+ primers. No false-positive HPV types were detected in the samples in any of the reference laboratories. All HPV types were detected by both laboratories in the lowest concentration included in the panel, except for HPV18, -31, -35, -59, and -68a, which were detected by only one of these laboratories. The results from the reference laboratory evaluation revealed that the panel performed as expected, and the panel was then distributed to participating laboratories worldwide.

data sets.

The proficiency of detecting HPV types by the type of assay is shown in [Table 2](#). Fifty-four data sets were 100% proficient (detected ≥ 50 IU of HPV16 and HPV18 in 5 μ l and 500 GE in 5 μ l of the other HPV types tested, also when present together with other HPV types), without having more than one false-positive result. As the Linear Array assay used a large (50 μ l) input volume in some laboratories, the Linear Array data sets did not test for the presence of amounts < 50 IU of HPV16 and HPV18 in 5 μ l and 500 genome equivalents in 5 μ l of the other HPV types. Two commercial assays, the HPV Direct-Flow Chip (Master Diagnostica) and the LCD Array (Chipron) both had 100% proficient results. More than two-thirds of the data sets generated by the Linear Array were 100% proficient. Several in-house assays based on general-primer PCR followed by hybridization (PGMY-CHUV) or Luminex were also 100% proficient.

To be considered proficient in this study, no more than one false-positive sample per data set was acceptable. The number of



HPV Direct Flow CHIP: A new human papillomavirus genotyping method based on direct PCR from crude-cell extracts[☆]

Elsa He
Sonia /
Javier S

^a Master Dic
^b Pathology
^c Pathology
^d Pathology
^e Pathology
^f Pathology
^g Pathology
^h Microbiol
ⁱ Pathology
^j Microbiolo
^k Pathology

In conclusion, comparative results obtained in this pilot study demonstrated that the performance of HPV Direct Flow CHIP is similar to that of LA, CLART, and HC2. Given that it offers direct PCR from clinical specimens without a DNA purification step, this novel test may be a valuable tool for automated, rapid, and sensitive HPV genotyping, especially in large-scale vaccine surveillance and epidemiology studies.

Article history:

Received 4 October 2012

Received in revised form 26 March 2013

Accepted 29 April 2013

Available online 13 May 2013

Keywords:

Human papillomavirus
HPV Genotyping
Hybrid Capture 2

HPV Direct Flow CHIP is a newly developed test for identifying 18 high-risk and 18 low-risk human papillomavirus (HPV) genotypes. It is based on direct PCR from crude-cell extracts, automatic flow-through hybridization, and colorimetric detection. The aim of this study was to evaluate the performance of HPV Direct Flow CHIP in the analysis of 947 samples from routine cervical screening or the follow-up of abnormal Pap smears. The specimens were dry swab samples, liquid-based cytology samples, or formalin-fixed paraffin-embedded tissues. The genotype distribution was in agreement with known epidemiological data for the Spanish population. Three different subgroups of the samples were also tested by Linear Array (LA) HPV Genotyping Test ($n = 108$), CLART HPV2 ($n = 82$), or Digene Hybrid Capture 2 (HC2) HPV DNA Test ($n = 101$). HPV positivity was 73.6% by HPV Direct Flow CHIP versus 67% by LA, 65.9% by HPV



Contents lists available at ScienceDirect

International Journal of Infectious Diseases

journal homepage: www.elsevier.com/locate/ijid



Prevalence and Genotype Distribution of Human Papillomavirus Infection among 12 076 Iranian Women[☆]



Fatemeh
Ehsan
Soheil
Soheil

¹ Department
² Department
³ Imam Hossein
⁴ Tehran University
⁵ Department
⁶ Iran University
⁷ Erfan Hospital
⁸ Department

A R T I C L E

Article history:
Received
Revised 2
Accepted

Keywords:
Cervical cancer
Human papillomavirus
Iranian population
Genotype

Conclusions

It has been suggested that HPV can become a dynamic threat. In the context of protective and preventive methods for HPV infection, the present study highlights the genotype distribution of this infection in the Iranian population. Determining the HPV prevalence and the distribution of specific genotypes in a large population of Iranian people can improve health policies implemented by government and health agencies. The results obtained from the present study may be useful for policymakers to specify cost-effective interventions and recommendations to improve national immunization against HPV and CC.

STD Direct Flow Chip Kit

Détection de
11
pathogènes





STD Flow Chip - 11 STD related pathogens ISTs



Détection simultanée de 11 agents pathogènes

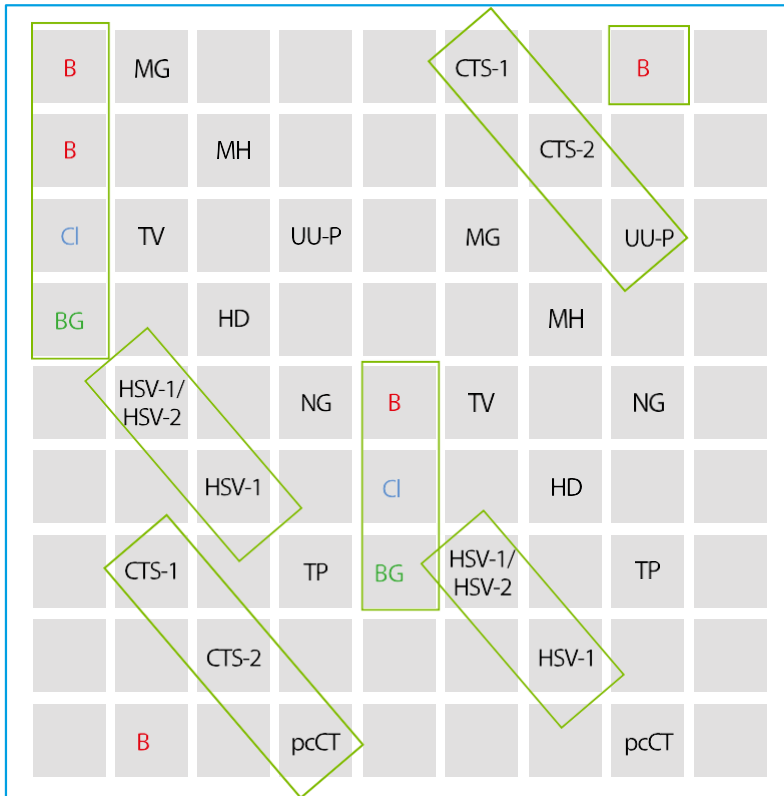

pcCT	<i>Chlamydia trachomatis</i>	CT-S1: Biovar Trachoma: Serovars A-K CT-S2: Biovar LGV: Serovars L1-L3
HD	<i>Haemophilus ducreyi</i>	
HSV-1/HSV-2 + HSV-1	Herpes simplex virus 1	
HSV-1/HSV-2	Herpes simplex virus 2	
MG	<i>Mycoplasma genitalium</i>	
MH	<i>Mycoplasma hominis</i>	
NG	<i>Neisseria gonorrhoeae</i>	
TP	<i>Treponema pallidum</i>	
TV	<i>Trichomonas vaginalis</i>	
UU-P	<i>Ureaplasma (urealyticum/parvum)</i>	



STD Flow Chip - 11 STD related pathogens STIs – diagnosis

Les tests de diagnostic précis des IST sont très utiles pour l'identification des infections asymptomatiques.

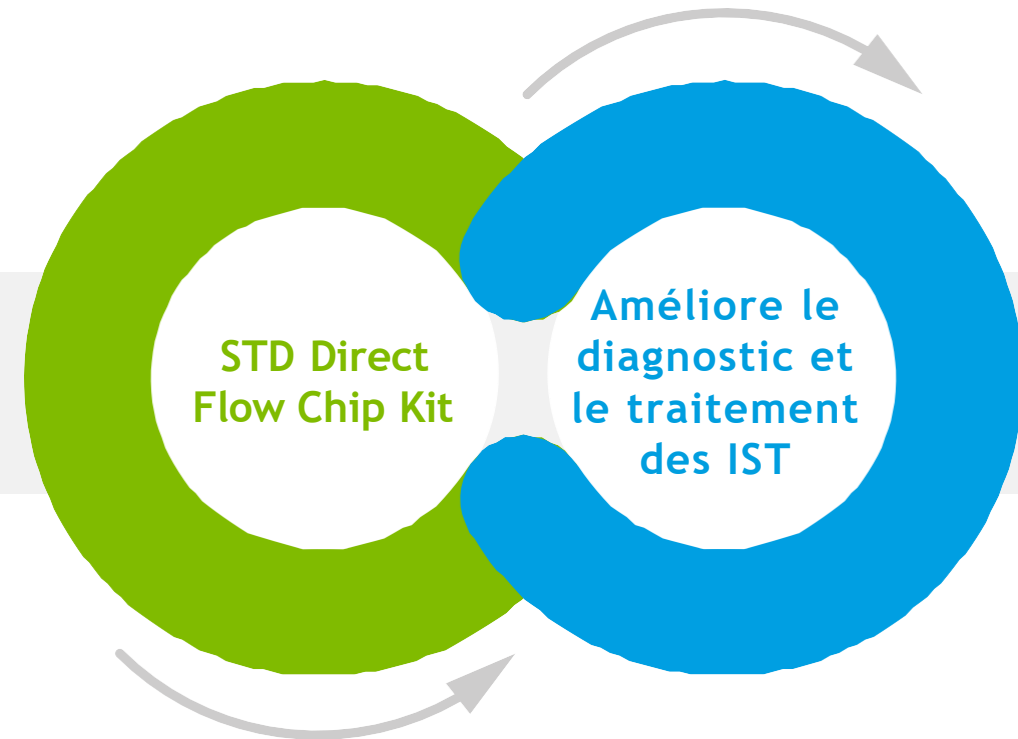



STD Flow Chip - 11 STD related pathogens STIs – scope of the problem

11 pathogènes

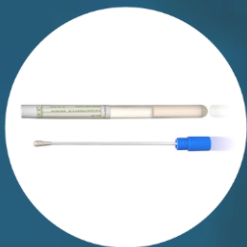

Écouvillonnage
Urètre
Endocervical
Vaginal

Anale et
gorge



Cytologie
endocervicale en
milieu liquide



sperme Urine



VEIL

Detection of sexually transmitted disease-causing pathogens from direct clinical specimens with the multiplex PCR-based STD Direct Flow Chip Kit

Antonio Barrientos-Durán ^{# 1}, Adolfo de Salazar ^{# 1}, Marta Alvarez-Estévez ¹, Ana Fuentes-López ¹, Beatriz Espadafor ², Federico Garcia ³

Affiliations + expand

PMID: 31902016 DOI: 10.1007/s10096-019-03686-w

Abstract

Pathogens causing sexually transmitted diseases (STDs) include viruses, bacteria, and parasites. The ability to rapidly and efficiently detect these pathogens in a single reaction still remains a health challenge. The aim of this study was to evaluate the clinical reliability and accuracy of the STD Direct Flow Chip Kit (Vitro, IVD-EC approved), which can simultaneously detect up to 9 different species of STD pathogens at once. This kit enables direct analysis-direct-PCR-of clinical specimens (urine, semen, endocervical, urethral, nasopharyngeal, and perianal swabs) without DNA purification for the following pathogens: *Chlamydia trachomatis* (serovars A-K and L1-L3), *Haemophilus ducreyi*, Herpes Simplex Virus (Types I and II), *Mycoplasma genitalium*, *Mycoplasma hominis*, *Neisseria gonorrhoeae*, *Treponema pallidum*, *Trichomonas vaginalis*, and *Ureaplasma*. The Anyplex™ II STI-7 Detection Kit (Seegene, IVD-EC) was used as the reference's method. Existing discordances were resolved using either a third molecular assay or DNA sequencing. Clinical performance was evaluated at two different stages: (i) from purified DNA of three hundred and fifty-eight clinical specimens with a diagnostic sensitivity (SE) and specificity (SP) of 99.4% and 100%, respectively, and an agreement of 99% (kappa index, $\kappa = 0.97$) with the reference's method and; (ii) by direct-PCR from six hundred and thirty-three specimens rendering SE, SP, and agreement values of 98.4%, 99.9%, and 98.0% ($\kappa = 0.95$), respectively. The STD Direct Flow Chip Kit constitutes a promising alternative to routine procedures in diagnostic, allowing direct analysis of specimens and enabling the detection of a broad panel of pathogens.

Keywords: Clinical specimens; DNA: DNA hybridization; Direct analysis; Multiplex-PCR based; Sexually transmitted diseases.

either a third molecular assay or DNA sequencing. Clinical performance was evaluated at two different stages: (i) from purified DNA of three hundred and fifty-eight clinical specimens with a diagnostic sensitivity (SE) and specificity (SP) of 99.4% and 100%, respectively, and an agreement of 99% (kappa index, $\kappa = 0.97$) with the reference's method and; (ii) by direct-PCR from six hundred and thirty-three specimens rendering SE, SP, and agreement values of 98.4%, 99.9%, and 98.0% ($\kappa = 0.95$), respectively.

The STD Direct Flow Chip Kit constitutes a promising alternative to routine procedures in diagnostic, allowing direct analysis of specimens and enabling the detection of a broad panel of pathogens.

AMR Direct Flow Chip Kit

Détéction de 20
gènes de résistance aux
ATB

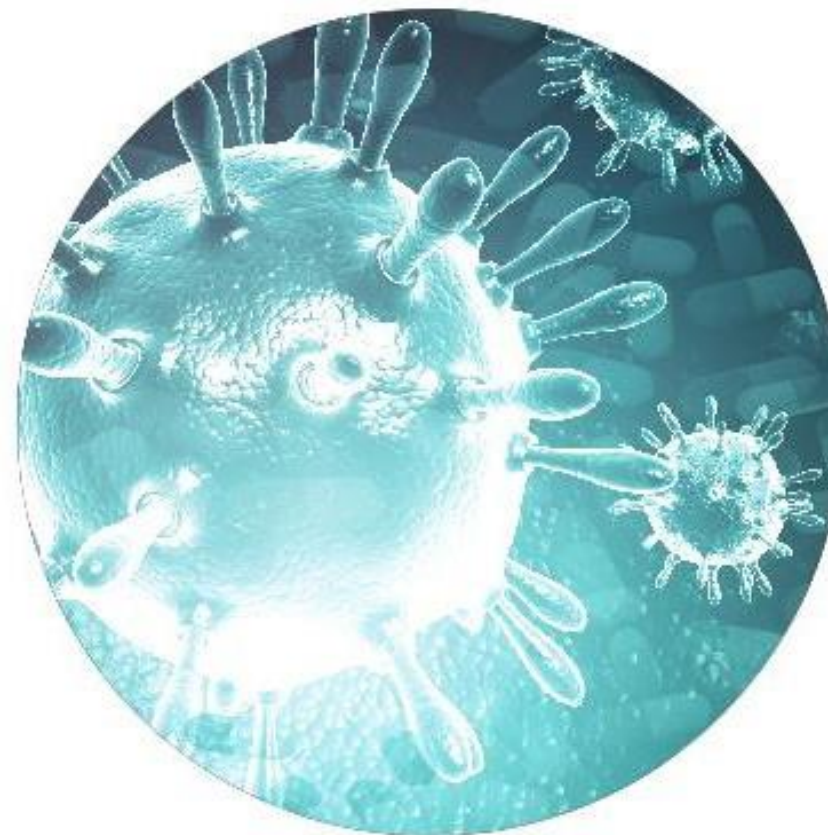



AMR Flow Chip - 20 antibiotic resistance genes

AMR Flow Chip Kit



Détection simultanée de **20 gènes de résistances aux ATB** présents chez les bactéries Gram-positif et Gram-négatif

B			kpc	spm			vanB	blaSHV-S	B
B			sme	ndm			vanA	ges	oxa23_like
Cl			nmc/imi	sim			mecA	vim	oxa24_like
BG				imp_like				gim	oxa48_like
			blaSHV	blaSHV-S				kpc	oxa51_like
	SA		blaCTX	blaSHV-SK	B			spm	oxa58_like
			ges	oxa23_like	Cl			sme	ndm
			vim	oxa24_like	BG			nmc/imi	sim
		mecA	gim	oxa48_like				blaSHV-SK	imp_like
		vanA		oxa51_like		SA		blaSHV	
	B	vanB		oxa58_like				blaCTX	

- SA: Staphylococcus aureus
- mecA: Methicillin resistance gene
- vanA: Vancomycin resistance gene
- vanB: Vancomycin resistance gene
- KPC: Class A carbapenemase
- SME: Class A carbapenemase
- NMC/IMI: Class A carbapenemase
- blaSHV: extended-spectrum β -lactamase CTX-M
- GES: Class A carbapenemase
- VIM: Class A carbapenemase
- GIM: Class A carbapenemase
- SMP: Class A carbapenemase
- NDM: Class A carbapenemase
- SIM: Class A carbapenemase
- Imp: Class B carbapenemase IMP3, 15, 19_like
- Oxa 23: Class D carbapenemase OXA23_like
- Oxa 24: Class D carbapenemase OXA24_like
- Oxa 48: Class D carbapenemase OXA48_like
- Oxa 51: Class D carbapenemase OXA51_like
- Oxa 58: Class A carbapenemase OXA58_like

B: Hybridization control

Cl: Exogenous amplification control

BG: Endogenous amplification control (β -globin human fragment)



AMR Flow Chip - 20 antibiotic resistance genes

AMR Flow Chip Kit



Détection simultanée de **20 gènes de résistances aux ATB** présents chez les bactéries Gram-positif et Gram-négatif

Carbapenemase class	Gene	Detected Allelic variant
A	ges	1, 2, 3, 4, 5, 6, 7, 8, 9, 10, 11, 12, 13, 14, 15, 16, 17, 18, 19, 20, 21, 22, 23, 24, 25 and 26
	sme	1, 2, 3, 4 and 5
	kpc	1, 2, 3, 4, 5, 6, 7, 8, 9, 10, 11, 12, 13, 14, 15, 16, 17, 18, 19, 20, 21, 22 and 23
	nmc/imi	1, 2, 3, 4, 5, 6, 7, 8 and 9
B	sim	sim
	gim	1 and 2
	spm	spm
	ndm	1, 2, 3, 4, 5, 6, 7, 8, 9, 10, 11, 12, 13, 14, 15 and 16
	vim	1, 2, 3, 4, 5, 6, 7, 8, 9, 10, 11, 12, 13, 14, 15, 16, 17, 18, 19, 20, 21, 22, 23, 24, 25, 26, 27, 28, 29, 30, 31, 32, 33, 34, 35, 36, 37, 38, 39, 40, 41, 42, 43, 44, 45 and 46
	imp	1, 2, 3, 5, 6, 8, 9, 10, 11, 15, 19, 20, 21, 24, 25, 28, 29, 30, 40, 41, 42 and 47
D	oxa-23-like	23, 27, 49, 73, 133, 146, 165, 166, 167, 168, 169, 170, 171 and 225
	oxa-24-like	24, 25, 26, 40, 72, 139 and 160
	oxa-48-like	48, 162, 163 and 181
	oxa-51-like	51, 60, 65, 66, 67, 68, 69, 70, 75, 76, 77, 78, 79, 80, 82, 83, 84, 88, 89, 90, 91, 92, 93, 94, 95, 98, 99, 106, 107, 108, 109, 110, 111, 112, 113, 115, 116, 117, 128, 130, 131, 132, 138, 144, 148, 149, 150, 172, 173, 174, 175, 176, 177, 178, 179, 180, 195, 196, 197, 194, 200, 201, 202, 203, 206, 208 and 223
	oxa-58-like	58, 96, 97 and 164



Panel de carba pénémases le plus étendu(CPMs)



Identification de 15 gènes CPM et détection de plus de 240 variantes alléliques



AMR Flow Chip - 20 antibiotic resistance genes

AMR Flow Chip Kit

ana
FLOW
technology



**Hémocultures
positives**

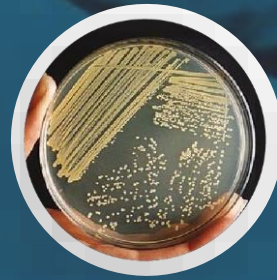

**Colonies
bactériennes**

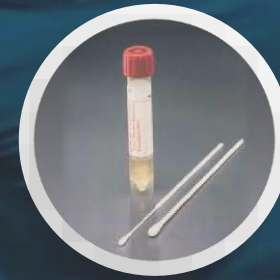

Exsudat
Rectale
Nasopharyngée

Sample preparation
Exsudats rectaux

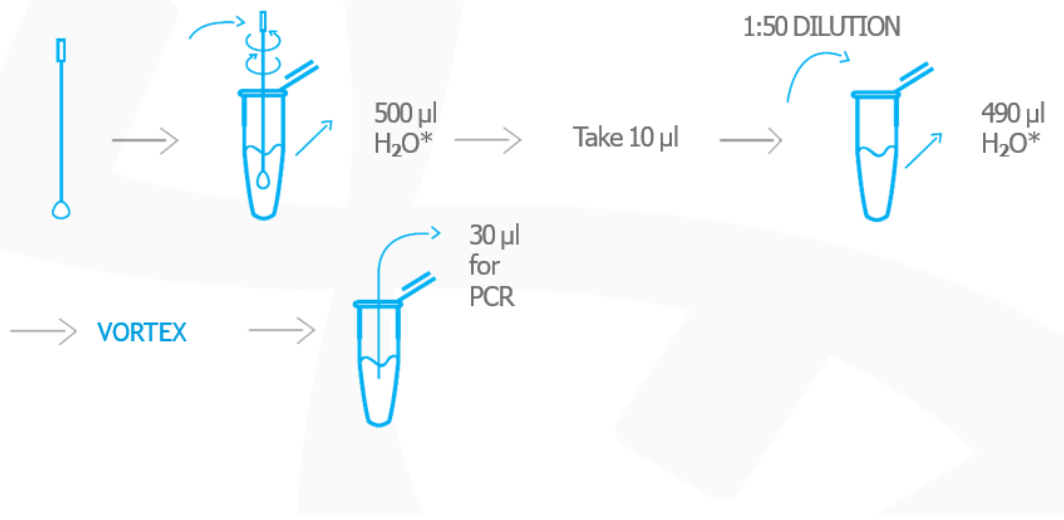

échantillon
Exsudats/aspirations nasopharyngés

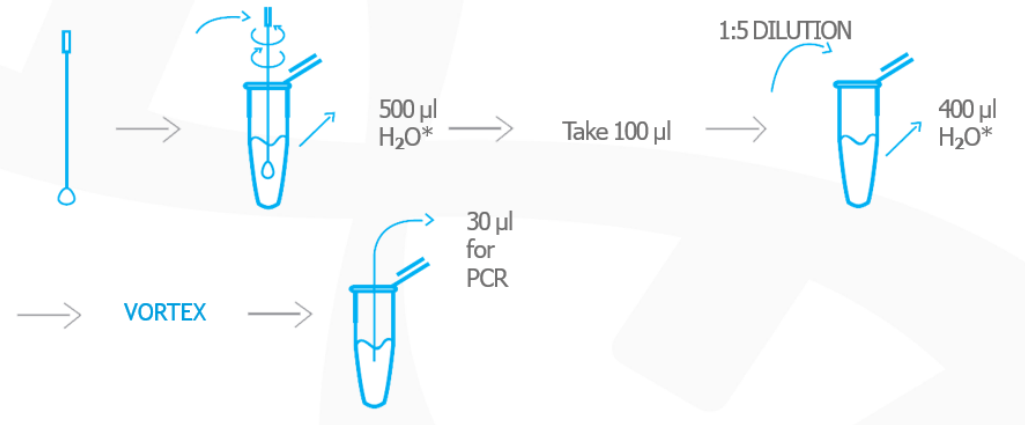

échantillon
hémoculture

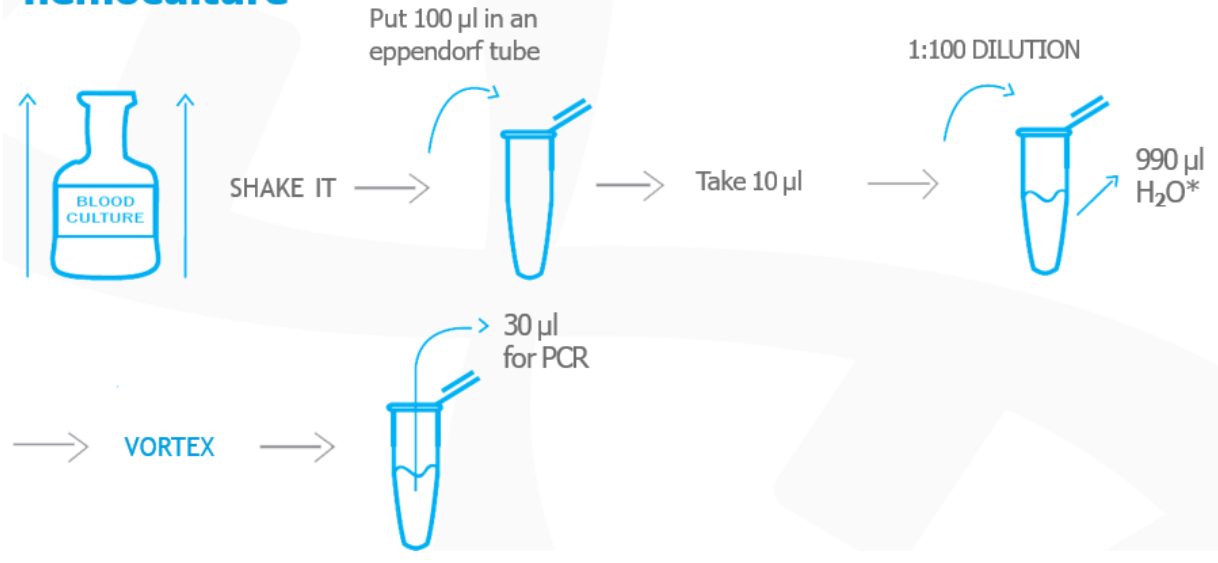

échantillon
Colonies bactériennes

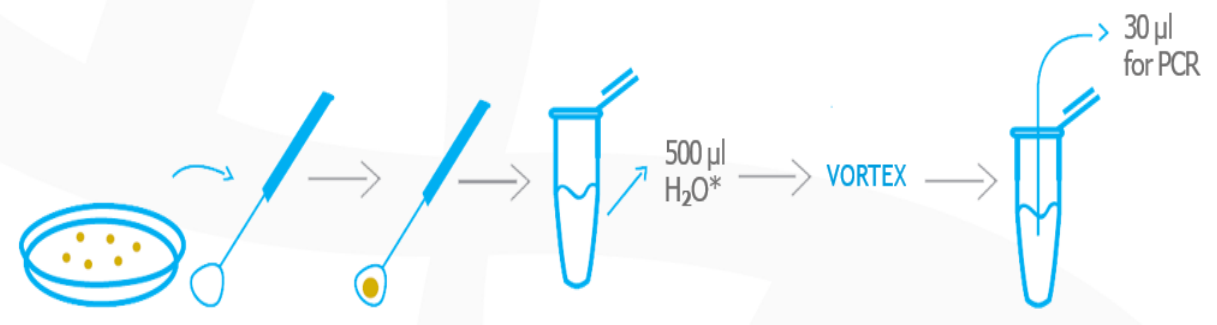



AMR Flow Chip - 20 antibiotic resistance genes

AMR Flow Chip Kit



Flux de travail unique sur le marché : écouvillons nasopharyngés et rectaux dans un seul tube/puce PCR

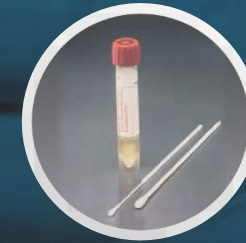

Exsudats rectaux
• Nasopharyngée

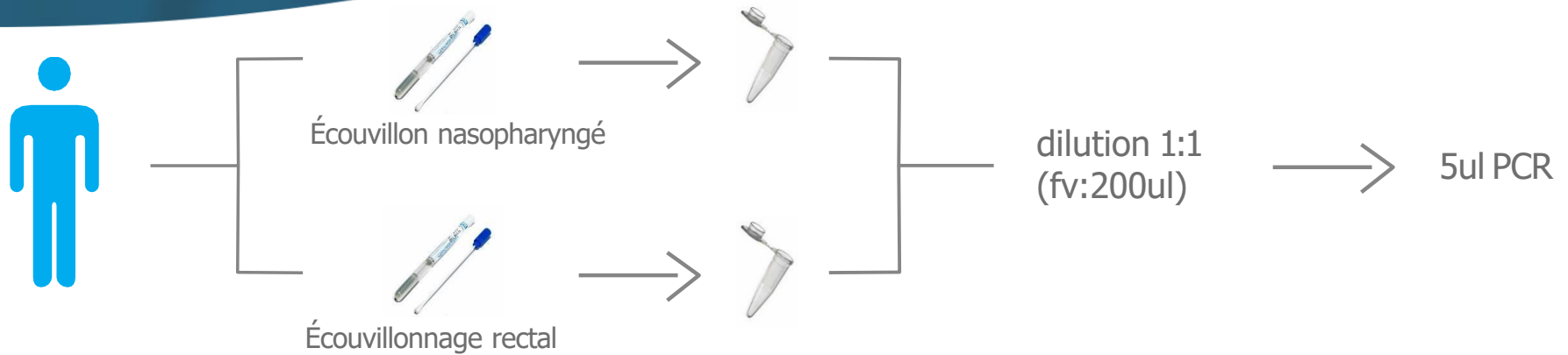

› [Enferm Infecc Microbiol Clin \(Engl Ed\). 2021 Jun-Jul;39\(6\):276-278. doi: 10.1016/j.eimce.2020.05.014.](#)

Evaluation of the "AMR Direct Flow Chip Kit" DNA microarray for detecting antimicrobial resistance genes directly from rectal and nasopharyngeal clinical samples upon ICU admission

Efthymia Protonotariou ¹, Georgios Meletis ², Dimitra Papadopoulou ², Melania Kachrimanidou ², Lilian Toptsi ², Lemonia Skoura ²

respectively).

Conclusion: The AMR Direct Flow Chip Kit is a useful alternative to phenotypic testing for rapid detection of resistance markers.

Keywords: ADN micromatriz; Carbapenemasas; Carbapenemases; DNA microarray; ESBLs; Genotypic resistance; MRSA; Resistencia genotípica; mecA.



Enfermedades Infecciosas y Microbiología Clínica

www.elsevier.es/eimc

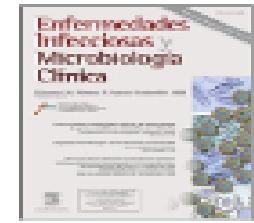

Brief report

Evaluation of the DNA microarray “AMR Direct Flow Chip Kit” for detection of antimicrobial resistance genes from Gram-positive and Gram-negative bacterial isolated colonies



Ignacio Torres Fink^a, Nuria Tormo Palop^b, Rafael Borrás Salvador^{a,c}, Javier Buesa Gómez^{a,c}, Concepción Gimeno Cardona^{b,c}, David Navarro Ortega^{a,c,*}

^a Microbiology Service, Hospital Clínico Universitario, Fundación INCLIVA, Valencia, Spain

^b Microbiology Service Consorcio Hospital General Universitario, Valencia, Spain

^c Department of Microbiology, School of Medicine, University of Valencia, Spain

ARTICLE INFO

Article history:

Received 27 July 2018

Accepted 26 December 2018

Keywords:

DNA microarray

Genotypic resistance

Carbapenemases

Extended-spectrum β -lactamases

mecA

vanA

vanB

ABSTRACT

Introduction: The AMR Direct Flow Chip assay allows the simultaneous detection of a large variety of antibiotic resistance genetic markers. To assess this kit's performance, we use isolated colonies as starting material. The assay has been approved by the European Economic Area as a suitable device for *in vitro* diagnosis (CE IVD) using clinical specimens.

Methods: A total of 210 bacterial isolates harbouring either one or more antimicrobial resistance genes including plasmid-encoded extended-spectrum β -lactamases (SHV, CTX-M) and carbapenemases (GES, SME, KPC, NMC/IMI, SIM, GIM, SPM, NDM, VIM, IMP, and OXA), *mecA*, *vanA* and *vanB*, and 30 controls were included.

Results: The assay displayed a sensitivity and specificity of 100% for all target genes included in the array.

Conclusion: The AMR Direct Flow Chip Kit is an accurate assay for detecting genes which commonly confer resistance to β -lactams and vancomycin from isolated colonies in culture of Gram-positive and Gram-negative bacteria.

MDR Direct Flow Chip Kit

Détection qualitative
de bactéries
multirésistantes

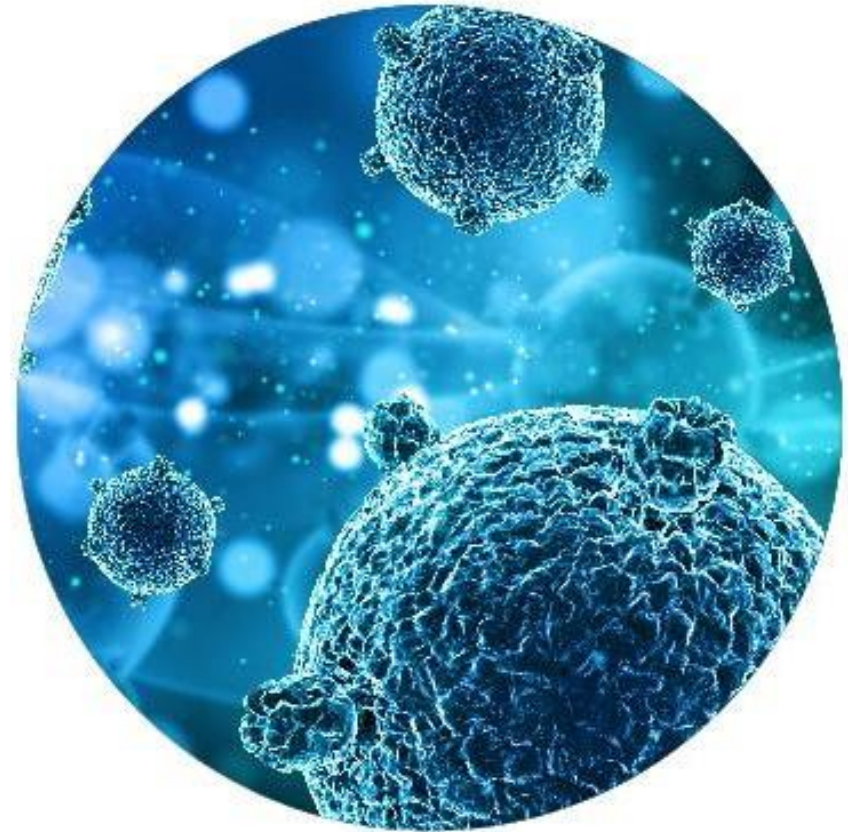

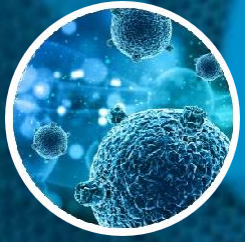

MDR Flow Chip | 5 bacterial species + 56 resistance markers

MDR Flow Chip Kit

5 espèces bactériennes + 56 marqueurs de résistance

- ✓ Staphylococcus aureus
- ✓ Escherichia coli
- ✓ Klebsiella pneumoniae
- ✓ Pseudomonas aeruginosa
- ✓ Acinetobacter baumannii

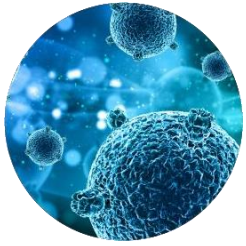

MDR Flow Chip | 5 bacterial species + 56 resistance markers

MDR Flow Chip Kit

5 espèces bactériennes + 56 marqueurs de résistance



aac (6')-Ib	Aminoglycosides
arma	
rmtB	
rmtC	
rmtF	
blaCMY	β-lactam antibiotics
blaDHA	
blaSHV-SK	Cephalosporins
blaSHV-S	
catB3	Chloramphenicol
Mcr1	Colistin
Mcr2	

gyrE-S83L	Quinolones
gyrE-S83L-D87G	
gyrE-S83L-D87G, parES80I	
gyrE-S83L-D87N	
gyrE-S83W-D87G	
gyrP-T83I	
gyrP-T83I-D87G	
gyrP-T83I-D87N	
parE-S80I	Macrolides / lincosamide / streptogramin
cfr	
ermA	Macrolides
ermB	
ermC	
mefA/E	
msrA	

Oxacilina-mecA	Carbapenems	• ndm
Vancomicina	• kpc	• sim
• vanA	• sme	• imp
• vanB	• nmc/imi	• oxa23_like
β-lactam antibiotic resistance	• ges	• oxa24_like
• blaSHV	• vim	• oxa48_like
• blaCTX-M	• gim	• oxa51_like
	• spm	• oxa58_like

oqxA	Phenicol/quinolone
oqxB	
qnrA	
qnrB	Quinolones
qnrS	
sul1	Sulfonamides
sul2	
sul3	

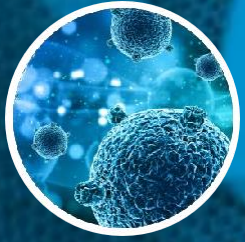

MDR Flow Chip | 5 bacterial species + 56 resistance markers
MDR Flow Chip Kit

5 espèces bactériennes + 56 marqueurs de résistance

ana
FLOW
technology



Hémoculture positives

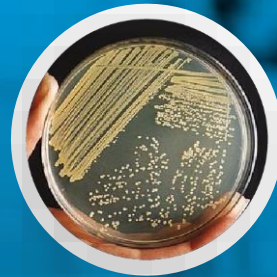

Colonies bactériennes

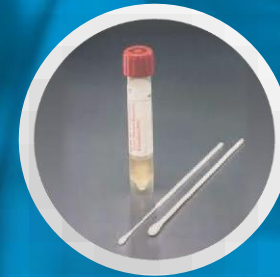

Rectal Exudates
Rectal
Nasopharyngeal

Echantillon Exsudats rectaux

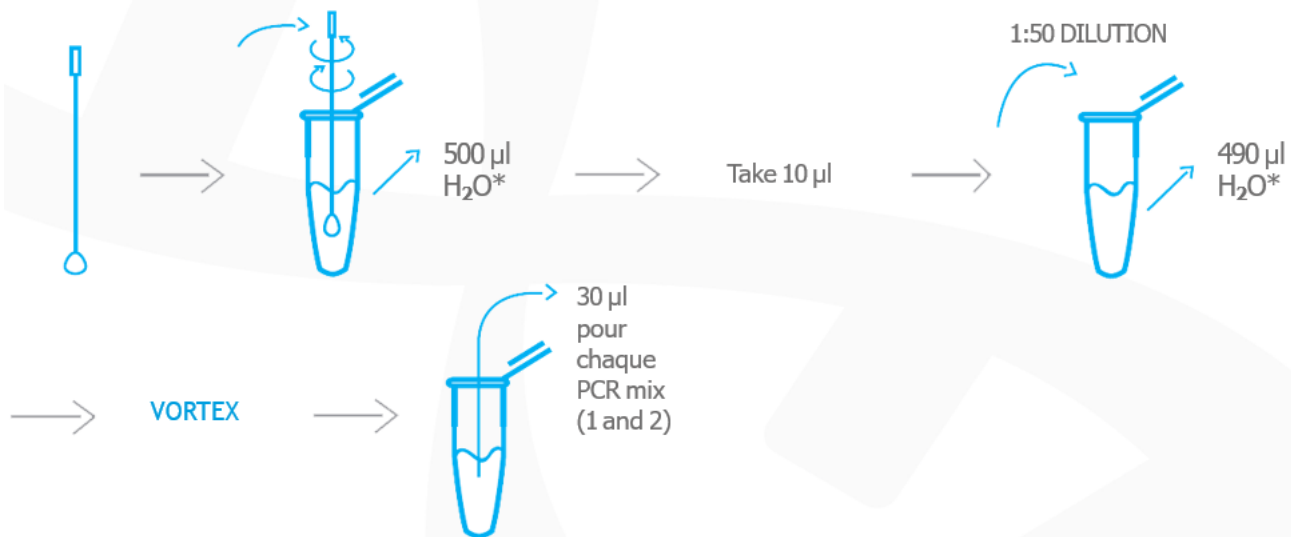

Échantillon Nasopharyngeal exudates / aspirates

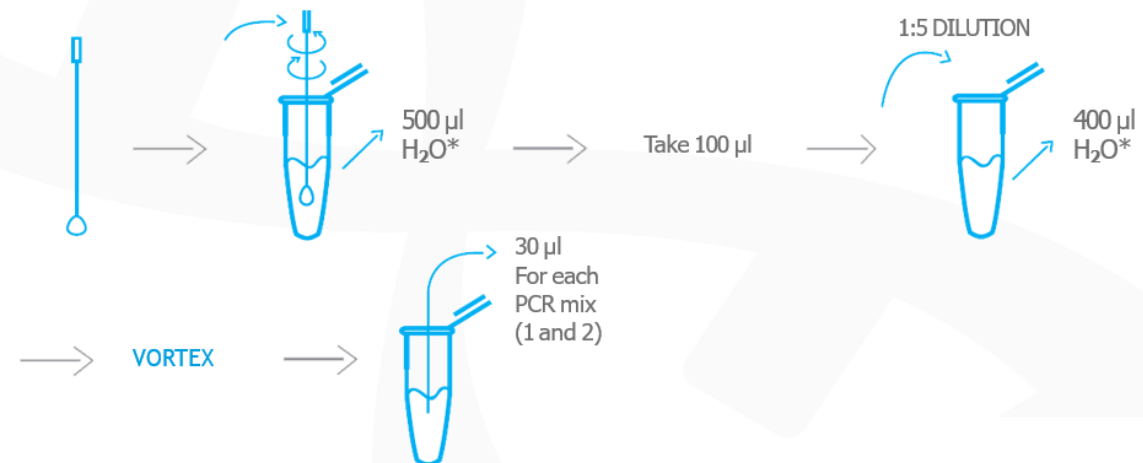

échantillon hémoculture

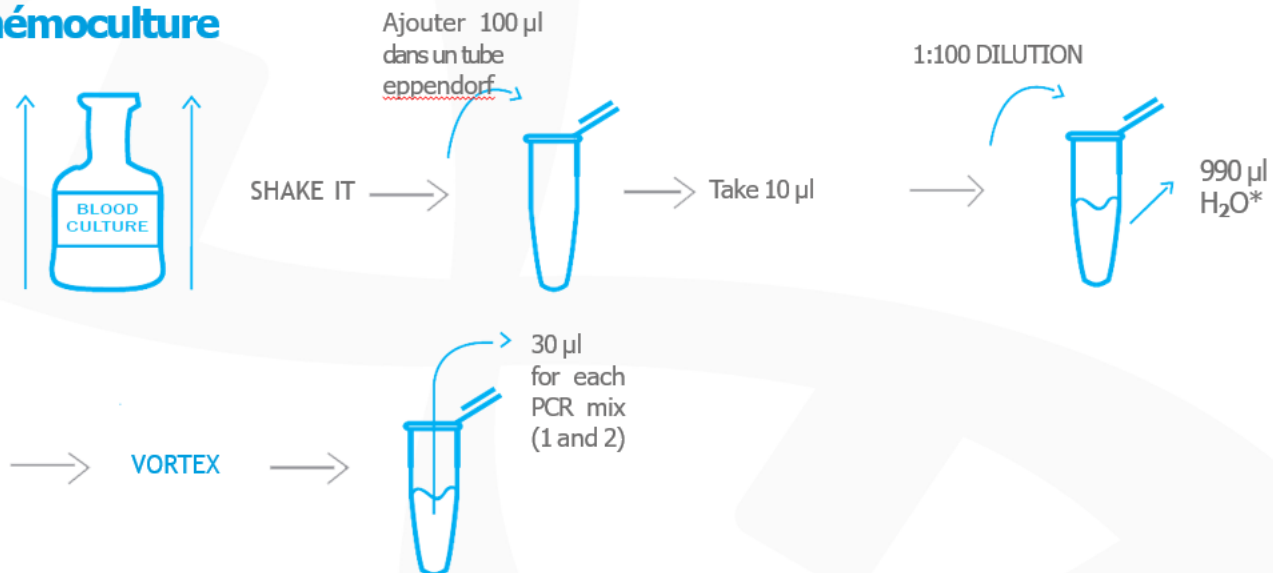

échantillon Colonies bactériennes

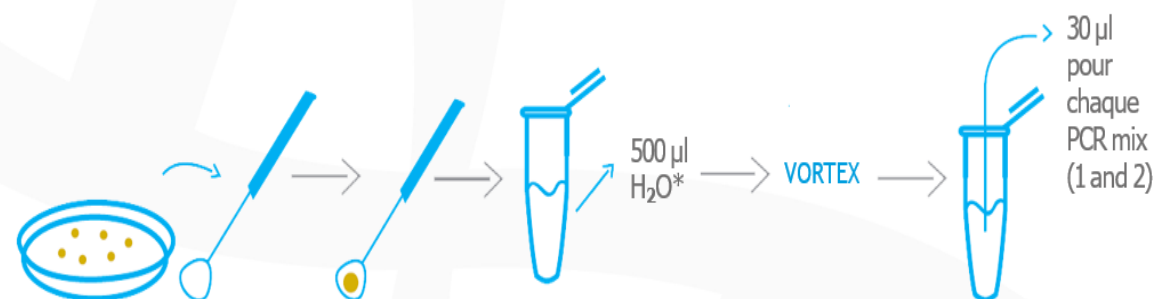

LOTS

PCR:

Chips:

Reagent:

SAMPLE DETAILS

ID SAMPLE

SAMPLE TYPE

MDR POSITIVE

Positive sample for:

Bacteria:

Klebsiella pneumoniae, Acinetobacter baumannii

Antibiotic Resistance:

Methicillin resistance gene (mecA), β -lactamase SHV, Extended-spectrum β -lactamase CTX-M, Carbapenemase NDM, Carbapenemase OXA23_like, Carbapenemase OXA24_like, Carbapenemase OXA48_like, Carbapenemase OXA51_like, Sulfonamides resistance gene (sul-1), Macrolides resistance gene (msrA), Macrolides resistance gene (ermA), Aminoglycosides resistance gene (aac(6')-Ib), Aminoglycosides resistance gene (armA), Quinolones or fluoroquinolones resistance gene (qnrB), Olaquinox resistance gene (oqxA)

Note: Absence of exogenous control in Mix-1.

The sample is negative for the rest of bacteria and antibiotic resistance included in the MDR flow chip test.

Hybridization of the biotinylated PCR products to the MDR CHIP, Post-hybridization washes, Streptavidin-Alkaline Phosphatase incubation, NBT-BCIP development and Automatic analysis of results.

LOTS

PCR:

Chips:

Reagent:

SAMPLE DETAILS

ID SAMPLE

hicharf2

SAMPLE TYPE

MDR POSITIVE

Positive sample for:

Bacteria:

Klebsiella pneumoniae, Acinetobacter baumannii

Antibiotic Resistance:

Methicillin resistance gene (mecA), β -lactamase SHV, Extended-spectrum β -lactamase CTX-M, Carbapenemase NDM, Carbapenemase OXA23_like, Carbapenemase OXA24_like, Carbapenemase OXA48_like, Carbapenemase OXA51_like, Sulfonamides resistance gene (sul-1), Macrolides resistance gene (msrA), Macrolides resistance gene (ermA), Aminoglycosides resistance gene (aac(6')-Ib), Aminoglycosides resistance gene (armA), Quinolones or fluoroquinolones resistance gene (qnrB), Olaquinox resistance gene (oqxA)

Note: Absence of exogenous control in Mix-1.

The sample is negative for the rest of bacteria and antibiotic resistance included in the MDR flow chip test.

*Spot "C12": Amplification control for reaction mixture Mix-2.
*Spot "RNaseP": DNA Control for reaction mixture Mix-1.
*Spot "BG": DNA Control for reaction mixture Mix-2.
*Spot "#": Pathogen specific probes.

Open camera or QR reader and
scan code to access this article
and other resources online.



Colonization of Residents and Staff of an Italian Long-Term Care Facility and an Adjacent Acute Care Hospital Geriatrics Unit by Multidrug-Resistant Bacteria

Maria Teresa Nitti,¹ Ferisa Sleghel,¹ Malgorzata Kaczor,¹ Richard Aschbacher,² Elena Moroder,²
Angela Maria Di Pierro,² Francesca Piscopiello,³ Melissa Spalla,³ Aurora Piazza,³
Roberta Migliavacca,³ and Elisabetta Pagani²

In 2022, we undertook a point prevalence screening study for *Enterobacterales* with extended-spectrum β -lactamases (ESBLs), high-level AmpC cephalosporinases and carbapenemases, and also methicillin-resistant *Staphylococcus aureus* (MRSA) and vancomycin-resistant enterococci (VRE) in a long-term care facility (LTCF) and the associated acute-care hospital Geriatrics unit in Bolzano, Northern Italy. Urine samples and rectal, inguinal, oropharyngeal, and nasal swabs were plated on selective agar plates. Metadata of the patients, including demographic data, were collected, and risk factors for colonization were determined. ESBL, AmpC, carbapenemase, and quinolone resistance genes were investigated by the HybriSpot 12 PCR AUTO System. The following colonization percentages by multidrug-resistant (MDR) bacteria have been found in LTCF residents: all MDR organisms, 59.5%; ESBL producers, 46.0% (mainly CTX-M-type enzymes); carbapenemase producers, 1.1% (one *Klebsiella pneumoniae* with KPC-type); MRSA, 4.5%; VRE, 6.7%. Colonization by MDR bacteria was 18.9% for LTCF staff and 45.0% for Geriatrics unit patients. Peripheral vascular disease, the presence of any medical device, cancer, and a Katz Index of 0 were significant risk factors for colonization of LTCF residents by MDR bacteria in univariate and/or multivariate regression analysis. To conclude, the ongoing widespread diffusion of MDR bacteria in the LTCF suggests that efforts should be strengthened on MDR screening, implementation of infection control strategies, and antibiotic stewardship programs targeting the unique aspects of LTCFs. ClinicalTrials.gov ID: 0530250-BZ Reg01 30/08/2022.

Keywords: long-term care facility, AmpC, ESBLs, carbapenemases, MRSA, VRE, *Enterobacterales*

Open camera or QR reader and
scan code to access this article
and other resources online.



Evaluation of the MDR Direct Flow Chip Kit for the Detection of Multiple Antimicrobial Resistance Determinants

Ángel Rodríguez-Villodres,¹⁻³ Antonio Galiana-Cabrera,⁴ Ignacio Torres Fink,⁵ Rosario Duran Jiménez,¹ José Miguel Cisneros,^{1-3,6} and José Antonio Lepe^{1-3,7}

The objective of this study was to evaluate the accuracy of the MDR Direct Flow Chip Kit for the detection of antimicrobial resistance (AMR) determinants from bacterial colonies. Ninety-two clinical isolates with known AMR determinants genotypically characterized were used. The MDR Direct Flow Chip Kit is a microarray-based assay that included 55 AMR determinants for beta-lactams (23), quinolones (13), aminoglycosides (5), macrolides (5), sulfonamides (3), colistin (2), vancomycin (2), chloramphenicol (1), and linezolid (1). The MDR Direct Flow Chip Kit correctly detects 52 of 53 AMR determinants tested. The *cfr* gene (linezolid resistance) was not detected. The global sensibility, specificity, positive predictive value, and the negative predictive value calculated were 98%, 100%, 100%, and 97%. The Cohen's Kappa coefficient calculated was 0.97 [95% Confidence Interval (0.90–1.03)]. **In conclusion**, the MDR Direct Flow Chip is an accurate assay for the detection of multiple AMR determinants in one simple reaction.

Keywords: antimicrobial resistance, rapid detection, microarray

The main advantage of the MDR Direct Flow Chip Kit compared with other molecular systems such as BioFire FilmArray⁹ or Xpert Carba-R¹⁰ is the high amount of antimicrobial resistance genes included in their panel (56). This provides a more realistic approximation to the real phenotype of the microorganism, optimizing the empiric antimicrobial treatment of patients with severe infections.

However, such techniques should still be used due to genotype/phenotype mismatches. This is relevant in *P. aeruginosa*, where phenotypic resistance to first-line antibiotics (ceftazidime, piperacillin, cefepime, or meropenem) is due to dysregulation of a mechanism not detected by the MDR Direct Flow Chip Kit. Further studies are necessary to solve this question.

This study has two main limitations. First, antimicrobial resistance determinants were validated with only 10 cases; in those cases, the test was performed in triplicate on three days to minimize the probability of a false positive. Second, we have not performed clonality studies in the isolates analyzed where only one bacterial species was tested; however, we used isolates from different hospitals, in different time periods, and from patients apparently not related.

In conclusion, the MDR Direct Flow Chip Kit has shown to be an accurate assay to detect the most frequent microorganisms associated with antimicrobial resistance as well as multiple antimicrobial-resistant determinants. This demonstrated accuracy along with the short time of response could make this kind of system very useful to improve the empirical antimicrobial treatment and, in consequence, decrease the probability of death in patients with severe infections.

Sepsis Direct Flow Chip Kit

Détection simultanée de plus de

- ✓ 36 espèces de bactéries
- ✓ de 20 gènes de résistance

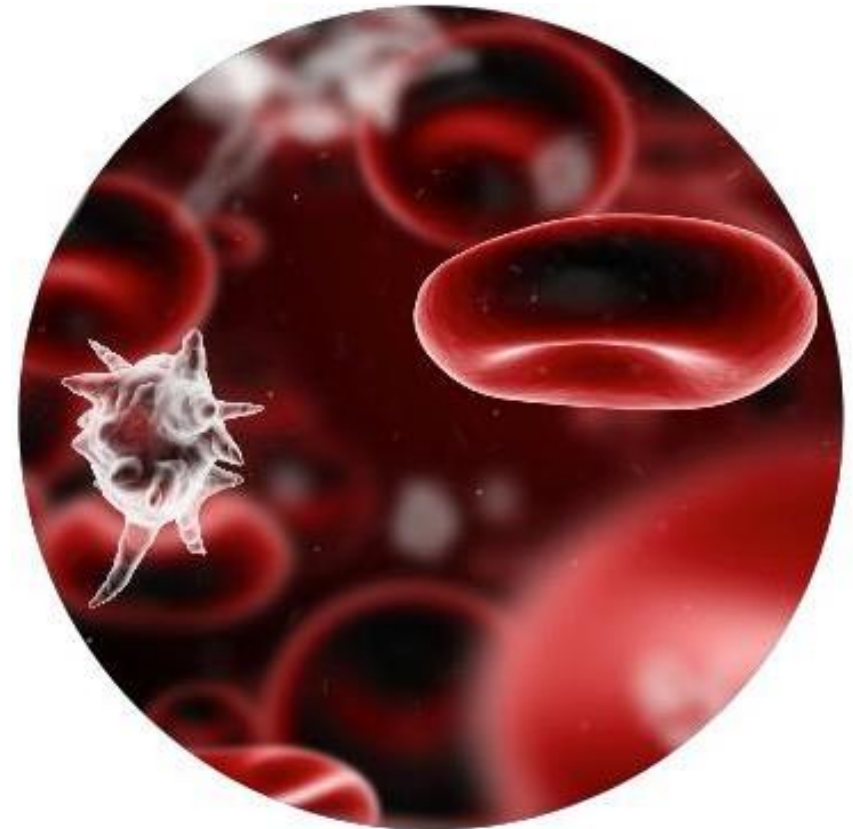

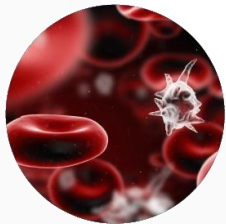

Sepsis Flow Chip | 36 pathogens + 20 antibiotic resistance genes

Sepsis Direct Flow Chip Kit



Bactéries Gram-positif

Staphylococcus Coagulase-Negative

- S. epidermidis
- S. haemolyticus
- S. capitis
- S. hominis-hominis
- S. intermedius

Staphylococcus aureus

Streptococcus spp.

- S. pasteurianus
- S. dysgalactiae
- S. gallolyticus
- S. macedonicus
- S. mitis/oralis

- S. salivarius

- S. infantarium

- S. pyogenes

- S. intermedius

Streptococcus pneumoniae

Streptococcus agalactiae

Streptococcus pyogenes

Listeria monocytogenes

Enterococcus spp.

- E. faecalis

- E. faecium

Bactéries Gram-négatif

Pseudomonas aeruginosa

Acinetobacter baumannii

Neisseria meningitidis

Stenotrophomonas maltophilia

Escherichia coli

Klebsiella pneumoniae

Serratia marcescens

Enterobacteriaceae

E. aerogenes

E. cloacae

K. oxytoca

K. pneumoniae

Morganella morganii

E. coli

S. marcescens

Citrobacter

Salmonella enterica

Proteus spp./Morganella

Marqueurs de résistance aux antibiotiques

Oxacilina-mecA

Vancomicina

vanA

vanB

β-lactam antibiotic
resistance

blaSHV

blaCTX-M

Carbapenems

kpc

sme

nmc/imi

ges

vim

gim

spm

ndm

sim

imp

oxa23_like

oxa24_like

oxa48_like

oxa51_like

oxa58_like

champignons

Candida albicans

Candida spp

- C. tropicalis
- C. parapsilosis
- C. krusei

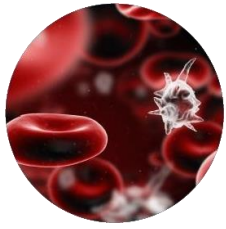

Sepsis Flow Chip | 36 pathogens + 20 antibiotic resistance genes

Sepsis Direct Flow Chip Kit



Évalué dans le cadre de
trois **programmes**
externes d'assurance
qualité



QMCD
Entérocoques
résistants à la
vancomycine

Examinations

VanA
VanB
VanC

QMCD B-lactmases
et carbapénémases
à spectre étendu

Examinations

TEM	KPC
SHV	VIM
CTX-M	NDM
IMP	Oxa-48

QMCD
Candida
spp

Examinations
Espèce de Candida

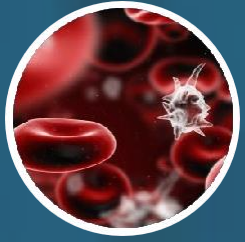

Sepsis Flow Chip | 36 pathogens + 20 antibiotic resistance genes

Sepsis Direct Flow Chip Kit

Large gamme de types d'échantillons

Flow
Technology



Hémocultures
positives



Colonies
bactériennes

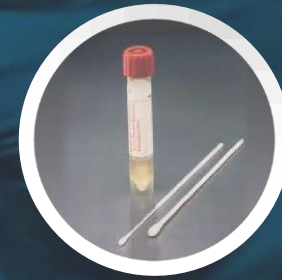

Rectal Exudates
Exsudats rectaux

Préparation d'échantillon Hémocultures

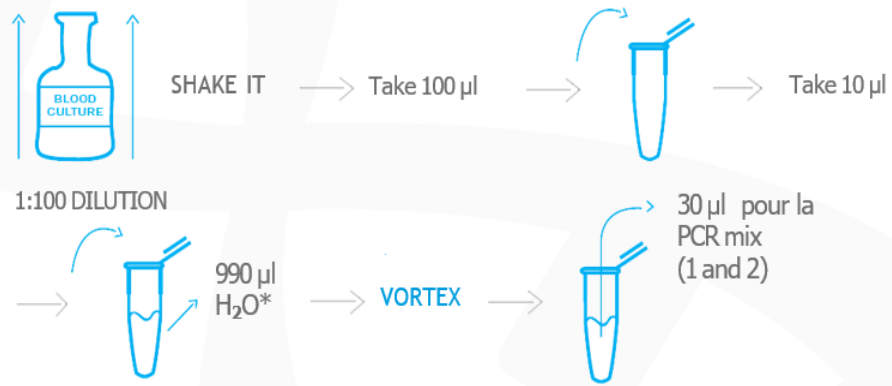

Préparation de l'échantillon Hémocultures hémopédiatrique

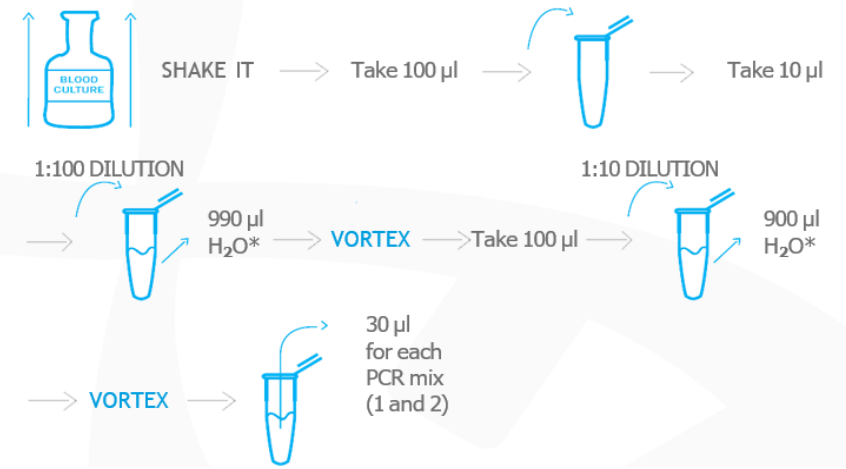

Exsudats rectaux

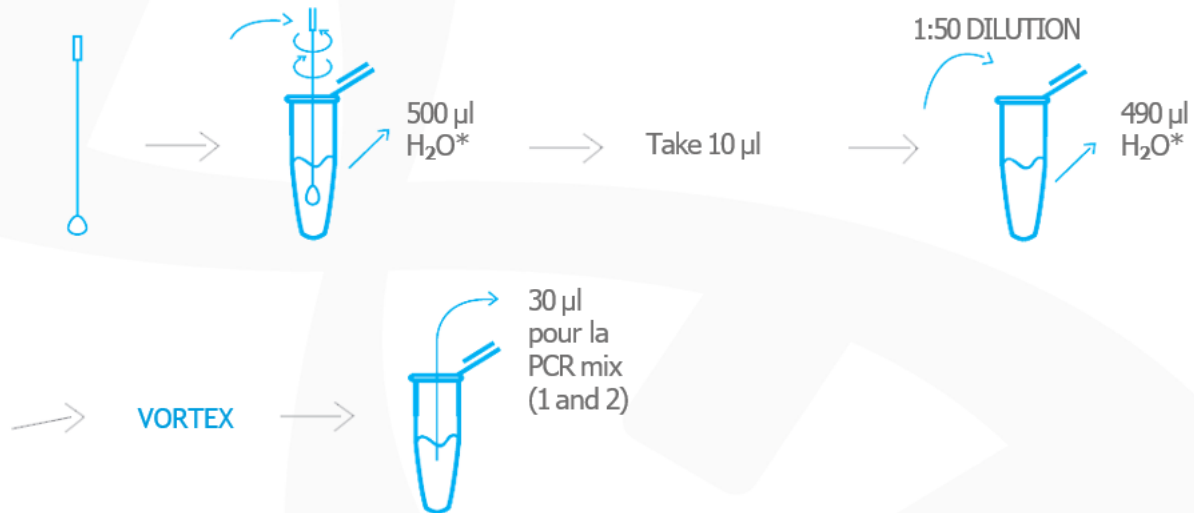

Échantillon: Colonies bactériennes

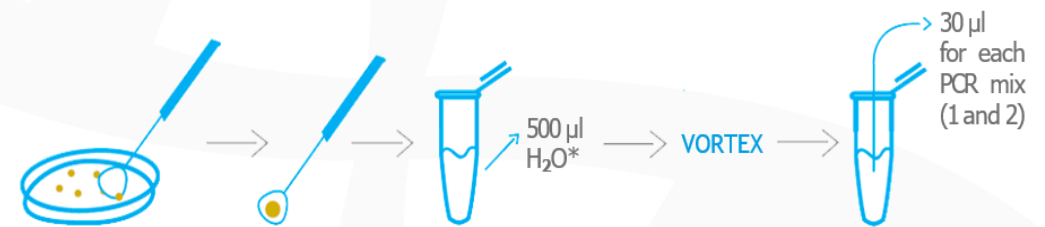

RESEARCH ARTICLE

Evaluation of the Sepsis Flow Chip assay for the diagnosis of blood infections

Antonio Gallana¹, Javier Coy², Adelina Gimeno², Noemi Marco Guzman², Francisco Rosales², Esperanza Merino², Gloria Royo¹, Juan Carlos Rodríguez^{2*}

1 Department of Microbiology, Hospital General Universitario de Elche, Fundación para el Fomento de la Investigación Sanitaria y Biomédica de la Comunidad Valenciana (FISABIO)-Elche, Spain, **2** Department of Microbiology, Hospital General Universitario de Alicante, Instituto de Investigación Sanitaria y Biomédica de Alicante (ISABIAL - FISABIO), Alicante, Spain, **3** Department of Infectious Diseases, Hospital General Universitario de Alicante, Instituto de Investigación Sanitaria y Biomédica de Alicante (ISABIAL - FISABIO), Alicante, Spain

* rodriguez_juadia@gva.es



Abstract

Background

Blood infections are serious complex conditions that generally require rapid diagnosis and treatment. The big challenge is to reduce the time necessary to make a diagnosis with current clinical microbiological methods so as to improve the treatment given to patients.

OPEN ACCESS

Citation: Gallana A, Coy J, Gimeno A, Guzman NM, Rosales F, Merino E, et al. (2017) Evaluation of the Sepsis Flow Chip assay for the diagnosis of blood

Conclusions

This is the first evaluation of SFC assay in clinical samples. This new method appears to be very promising by combining the high number of distinct pathogens and genetic resistance determinants identified in a single assay. Further investigations should be done to evaluate the usefulness of this assay in combination with clinical multidisciplinary groups

Funding: This work was supported by Hospital General Universitario de Alicante (USP-14-270) <http://alicante.san.gva.es/>; Fundación Soria Melgudo (no number) <http://www.f-soria.es/>; and FISABIO (USP-14-296) <http://isabial.san.gva.es/>.

Competing Interests: The authors have declared that no competing interests exist.

Conclusions

This is the first evaluation of SFC assay in clinical samples. This new method appears to be very promising by combining the high number of distinct pathogens and genetic resistance determinants identified in a single assay. Further investigations should be done to evaluate the usefulness of this assay in combination with clinical multidisciplinary groups

Echantillon Exsudats rectaux

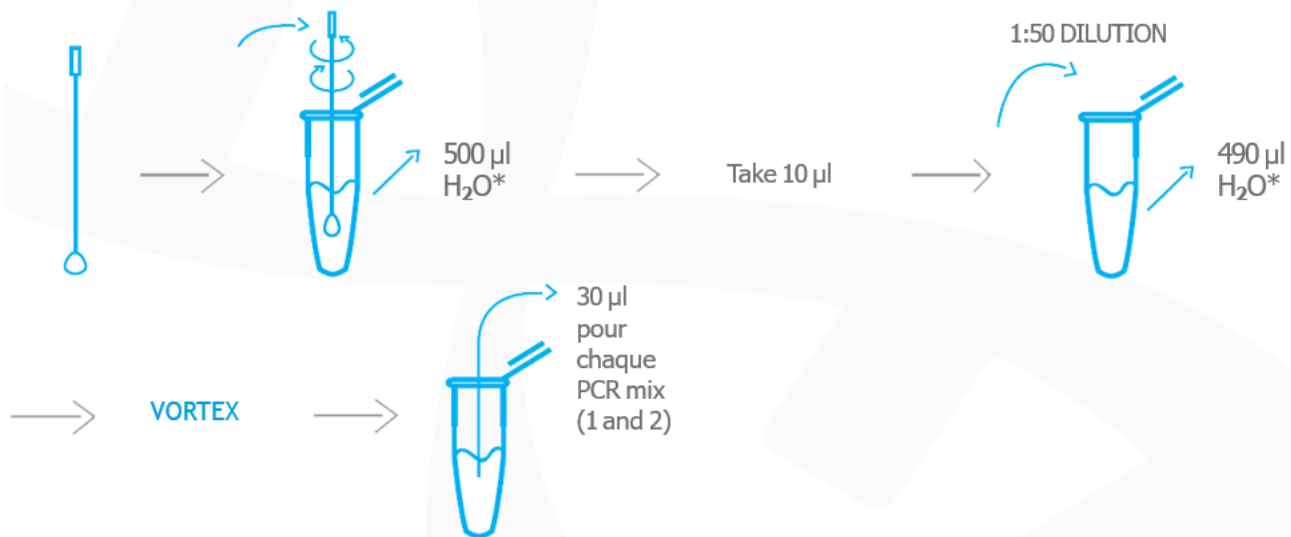

Échantillon Nasopharyngeal exudates / aspirates

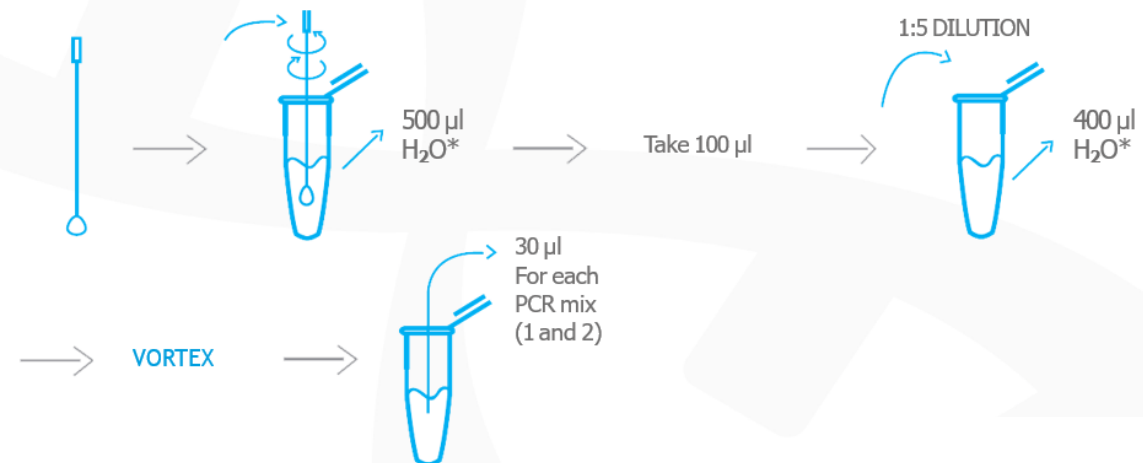

échantillon hémoculture

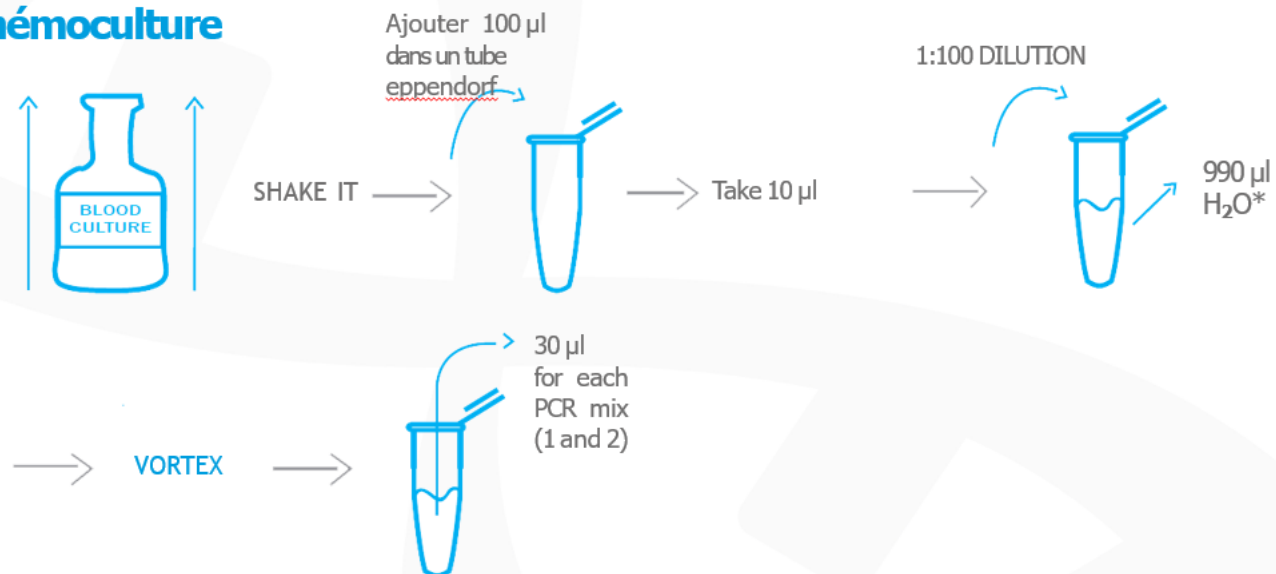

échantillon Colonies bactériennes

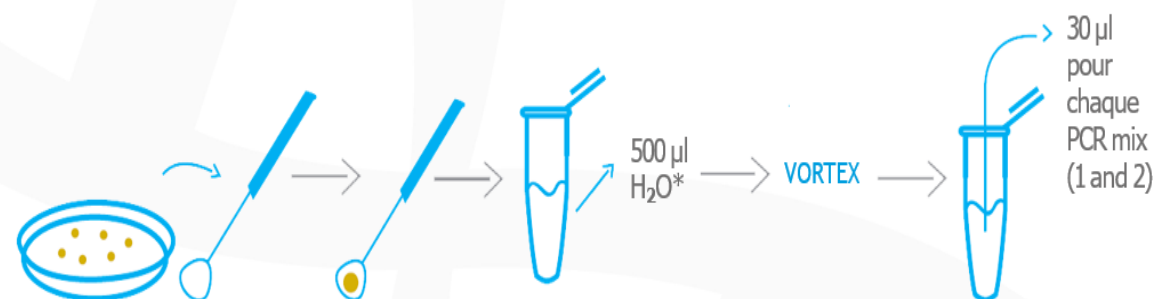

Respiratory Flow Chip Kit

Détection des principaux
agents pathogènes à l'origine
d'infections aiguës des voies
respiratoires

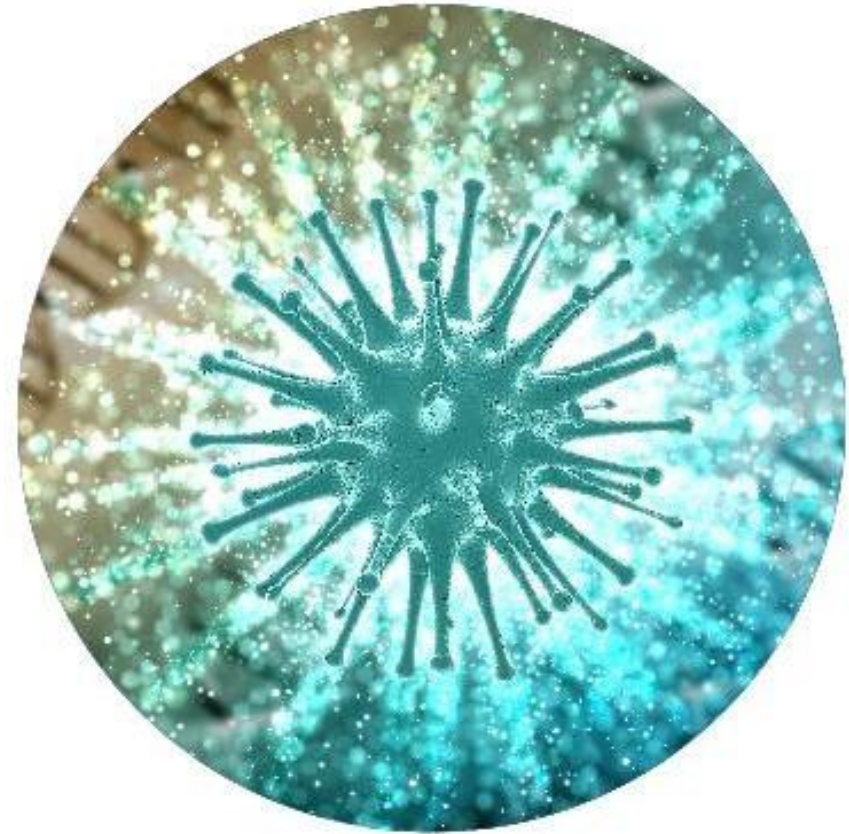

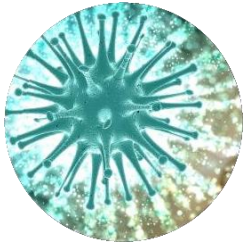

Respiratory Flow Chip | 23 main infectious agents, respiratory diseases

Respiratory Flow Chip Kit



B	FluA	PIV-1	CoV-OC43		RNaseP	RSV-A	B	
B	FluA-H1N1	PIV-2	BP		BG	RSV-B	CoV-229E	
CI-1	FluA-H3	PIV-3	BPP			RhV	CoV-HKU1	
CI-2	FluB	PIV-4	MP			PIV-1	CoV-NL63	
RNaseP	MPV	AdV	EV	B	FluA	PIV-2	BPP	
BG	RSV-A	Bov	CoV-2	CI-1	FluA-H1N1	PIV-3	MP	
	RSV-B	CoV-229E	SARS	CI-2	FluA-H3	PIV-4	EV	
	RhV	CoV-HKU1		CoV-OC43	FluB	AdV	CoV-2	
	B	CoV-NL63		BP	MPV	Bov	SARS	

Identification des principaux agents infectieux **des maladies respiratoires**

- Adenovirus
- Influenza Type A: subtype H3 and subtype H1N1 (pandemic 2009)
- Influenza Type B
- Coronavirus 229E
- Coronavirus HKU-1
- Coronavirus NL63
- Coronavirus OC43
- Coronavirus SARS-CoV2: RdRP (specifi of SARS-CoV-2) and E (generic for all Sarbecovirus)
- Parainfluenza type 1
- Parainfluenza type 2
- Parainfluenza type 3
- Parainfluenza type 4
- Bocavirus
- Metapneumovirus
- Sincitial Respiratory virus type A
- Sincitial Respiratory virus type B
- Rinovirus
- Enterovirus (EV-A, EV-B, EV-D)
- Bordetella pertussis
- Bordetella parapertusis
- Mycoplasma pneumoniae

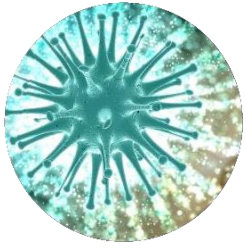

Respiratory Flow Chip | 23 main infectious agents, respiratory diseases

Respiratory Flow Chip Kit



B	FluA	PIV-1	CoV-OC43		RNaseP	RSV-A	B	
B	FluA-H1N1	PIV-2	BP		BG	RSV-B	CoV-229E	
CI-1	FluA-H3	PIV-3	BPP			RhV	CoV-HKU1	
CI-2	FluB	PIV-4	MP			PIV-1	CoV-NL63	
RNaseP	MPV	AdV	EV	B	FluA	PIV-2	BPP	
BG	RSV-A	Bov	CoV-2	CI-1	FluA-H1N1	PIV-3	MP	
	RSV-B	CoV-229E	SARS	CI-2	FluA-H3	PIV-4	EV	
	RhV	CoV-HKU1		CoV-OC43	FluB	AdV	CoV-2	
	B	CoV-NL63		BP	MPV	Bov	SARS	

Identification des principaux agents infectieux des **maladies respiratoires**

Validé à partir de matériel génétique purifié provenant de différents types d'échantillons clinique

- exsudats nasopharyngés et oropharyngés
- nasopharyngeal aspiration nasopharyngée lavage
- Lavage broncho-alvéolaire

- Inclut à la fois les virus et les bactéries dans le même test
- Participation réussie aux panels de compétences QCMD

Microbia Multiplex

The identi
infections wa
reverse dot bl
based on D
Diagnostica,
multiplex PC
5 µl of gen
primers foll
the membra
most import
the respirat
colorimetric
by the Hybri
Seville, Spair

In **conclusion**, our data demonstrated a profound change in the typical epidemiology of pediatric respiratory pathogens during 2020–2021 winter season in a large cohort of children in northeast Italy. Influenza and RSV infections were not detected, whereas HRV was the main pathogen during winter. Social distancing measures, in particular face masks use and school closure, did have an impact on the circulation of common respiratory pathogens. The use of a multiplex PCR allowed a rapid and useful differential diagnosis of common respiratory infections in children during COVID-19 pandemic. Given the novelty of these findings, continuing surveillance for a delayed spread, in particular of RSV and influenza, seems mandatory.

by a camera and analyzed by the Hybri-Soft software reporting

34, $p < 0.001$). Adenovirus, observed in 11.6%
sk factor (RRR = 6.44, $p < 0.001$). Bocavirus
clusion, our results showed that social isolation

Tick Borne Bacteria Flow Chip Kit

Identification des agents
pathogènes bactériens
transmis par les
arthropodes

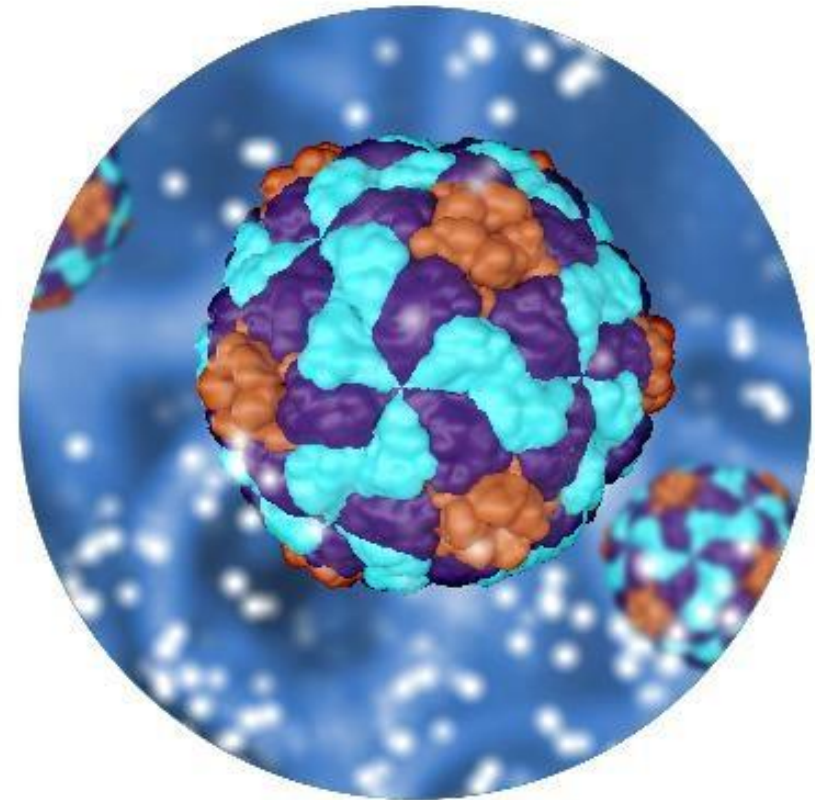

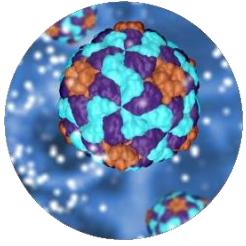

Tick-borne Flow Chip | 7 tick-borne bacteria genera

Tick-borne Direct Flow Chip Kit

Identification des agents pathogènes bactériens transmis par les arthropodes

B			FR				B	
B	GR				EH		BOR	
CI	TG		BAR		AN			
BG	SFG						COX	
			BAR-2	B				FR
				CI				
	EH		BOR	BG	GR			BAR
	AN				TG			BAR-2
	B		COX		SFG			

AN	<i>Anaplasma</i>	<i>Anaplasma spp.</i>
		<i>A. phagocytophilum</i>
		<i>Bovis</i>
		<i>A. equi</i>
EH	<i>Ehrlichia</i>	<i>Ehrlichia chaffeensis</i>
		<i>E. ewingii</i>
		<i>Candidatus Neoehrlichia mikurensis</i>
BOR	<i>Borrelia spp.</i>	
BAR + BAR-2	<i>Bartonella spp.</i>	
COX	<i>Coxiella burnetii</i>	
GR		<i>Rickettsia spp</i>
GR + TG	<i>Rickettsia</i>	Rickettsia typhus group
GR + SFG		Rickettsia spotted fever group
FR	<i>Francisella spp</i>	

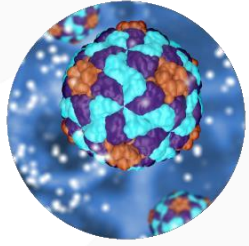

Tick-borne Flow Chip | 7 tick-borne bacteria genera

Tick-borne Direct Flow Chip Kit

Identification of bacterial arthropod-borne pathogens



Validated sample types

- ✓ Echantillons clinique du patient
- ✓ ADN total d'arthropodes qui transporter la bactérie d'intérêt
- ✓ Échantillons de réservoirs d'animaux

Validated extraxtion systems

- ✓ DNA Mini Kit

Bacterial CNS Flow Chip Kit

Kit de diagnostic
des bactéries et des
champignons responsables
de la méningite et de
l'encéphalite chez
l'homme



Bacterial CNS Flow Chip Kit

9 bacteria and 1 fungus CNS infections

B							B	
B							MTB	
CI	NEISS	AGAL	TPA		LIS	CRYP	BOR	
BG								
	SPNEU	HINF	COX	B	NEISS	AGAL	TPA	
				CI				
	LIS	CRYP	BOR	BG	SPNEU	HINF	COX	
	MTB							
	B							

Organism

Mycobacterium tuberculosis complex

Streptococcus pneumoniae

Streptococcus agalactiae

Haemophilus influenzae

Listeria monocytogenes

Treponema pallidum

Neisseria meningitidis

Coxiella burnetii

Borrelia burgdorferi

Cryptococcus neoformans (fungus)

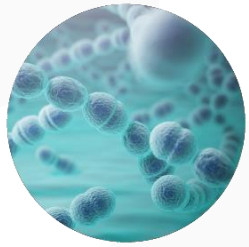

Bacterial CNS Flow Chip | 9 bacteria and 1 fungus CNS infections

Bacterial CNS Flow Chip Kit



Les méthodes actuellement utilisées pour leur diagnostic sont très laborieuses et **ne présentent pas toujours une spécificité à 100 %.**

ORGANISM	TARGET GENE
Neisseria meningitidis	ctrA
Haemophilus influenzae	gyrB
Streptococcus pneumoniae	ply
Streptococcus agalactiae	cfb
Listeria monocytogenes	hly
Cryptococcus neoformans	185
Treponema pallidum	PolA
Mycobacterium tuberculosis complex	IS6110
Coxiella burnetii	trans
Borrelia burgdorferi	osp

Analytical validation of viral CNS Flow Chip kit for detection of acute meningitis and encephalitis

Mercedes Pérez-Ruiz ¹, Irene Pedrosa-Corral ², Sara Sanbonmatsu-Gámez ²,
Cristina Gómez-Camarasa ², José María Navarro-Marí ²

Affiliations + expand

PMID: 29902492 DOI: 10.1016/j.jviromet.2018.06.006

Abstract

A new molecular assay (Viral CNS Flow Chip kit, Master Diagnóstica, Spain) has been developed for the detection of eight viruses causing acute meningitis and encephalitis, i.e. herpes simplex viruses 1-2, varicella zoster virus, human enterovirus, human parechovirus, Toscana virus, human cytomegalovirus and Epstein Barr virus. The new assay is a multiplex one-step RT-PCR followed by automatic flow-through hybridization, colorimetric detection and image analysis. The limit of detection was 50 copies/reaction, and 10 copies/reaction for human enterovirus and the other seven viruses, respectively. The analytical validation was performed with nucleic acids extracted from 268 cerebrospinal fluid samples and the results were compared with routine molecular assays. An excellent coefficient of agreement was observed between V-CNS and routine assays [kappa index: 0.948 (95%CI: 0.928-0.968)]. The overall sensitivity and specificity was 95.9% (95%CI: 91.2-98.3%) and 99.9% (95%CI: 99.6-100%), respectively. Viral CNS Flow Chip kit is an efficient multiplex platform for the detection of the main viruses involved in acute meningitis and encephalitis. The inclusion of a TOSV genome target may improve the laboratory diagnosis of viral neurological infections in endemic areas.

Bacterial CNS Flow Chip Kit: evaluación de un nuevo kit diagnóstico de infecciones bacterianas en el SNC

Antonio Galiana¹, Irene Pedrosa Corral², Ester Lara³, Mercedes Pérez Ruiz², Asunción Olmo³, Sara Sanbonmatsu Gámez², Juan Carlos

Roc
¹ Se
² Se
³ M

RESULTS

The BCNS system allows pathogen identification results to be obtained in less than 4 hours from CSF. The kit has been clinically validated retrospectively with purified DNA from CSF of 27 positive and 30 negative cases for the pathogens included in the BCNS panel, which had been previously diagnosed by bacterial culture and standard identification techniques. The diagnostic sensitivity and specificity obtained with BCNS was 100%. Prospective studies with routine clinical samples are currently underway to determine the impact this methodology could have on microbiological diagnosis.

CONCLUSIONS

The BCNS system allows pathogen identification results to be obtained in less than 4 hours from CSF. BCNS is a semi-automated, reliable and rapid system that allows the simultaneous detection of the main bacteria and fungi associated with CNS infections. BCNS could be an excellent alternative to standard identification methods.

40 min

70 min

Figura 1: Esquema de flujo de trabajo usado en BCNS.

RESULTADOS

El sistema BCNS permite obtener resultados de identificación de patógenos en menos de 4 horas a partir del LCR. El kit se ha validado

da.

ana
rior
icas
CNS
> de
(NF),
(SS),
tiae
osis
OR)
ción
trol
eno

IN
La
tas
ref
me
cef
ba:
mú
ba:
ser
tie
El
mé
ho
(SN