

Hépatite C chronique

Place du Siméprévir

Badreddine Kilani

Symposium Janssen

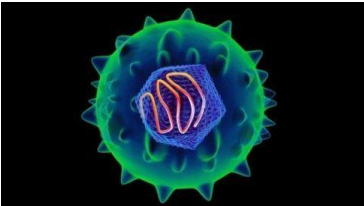

Hammamet , 17 Avril 2015

Introduction

- Problème de santé publique
- 150 - 180 Millions personnes infectées
- Morbi-mortalité importante
- 350 000 décès

L'hépatite C est une maladie systémique

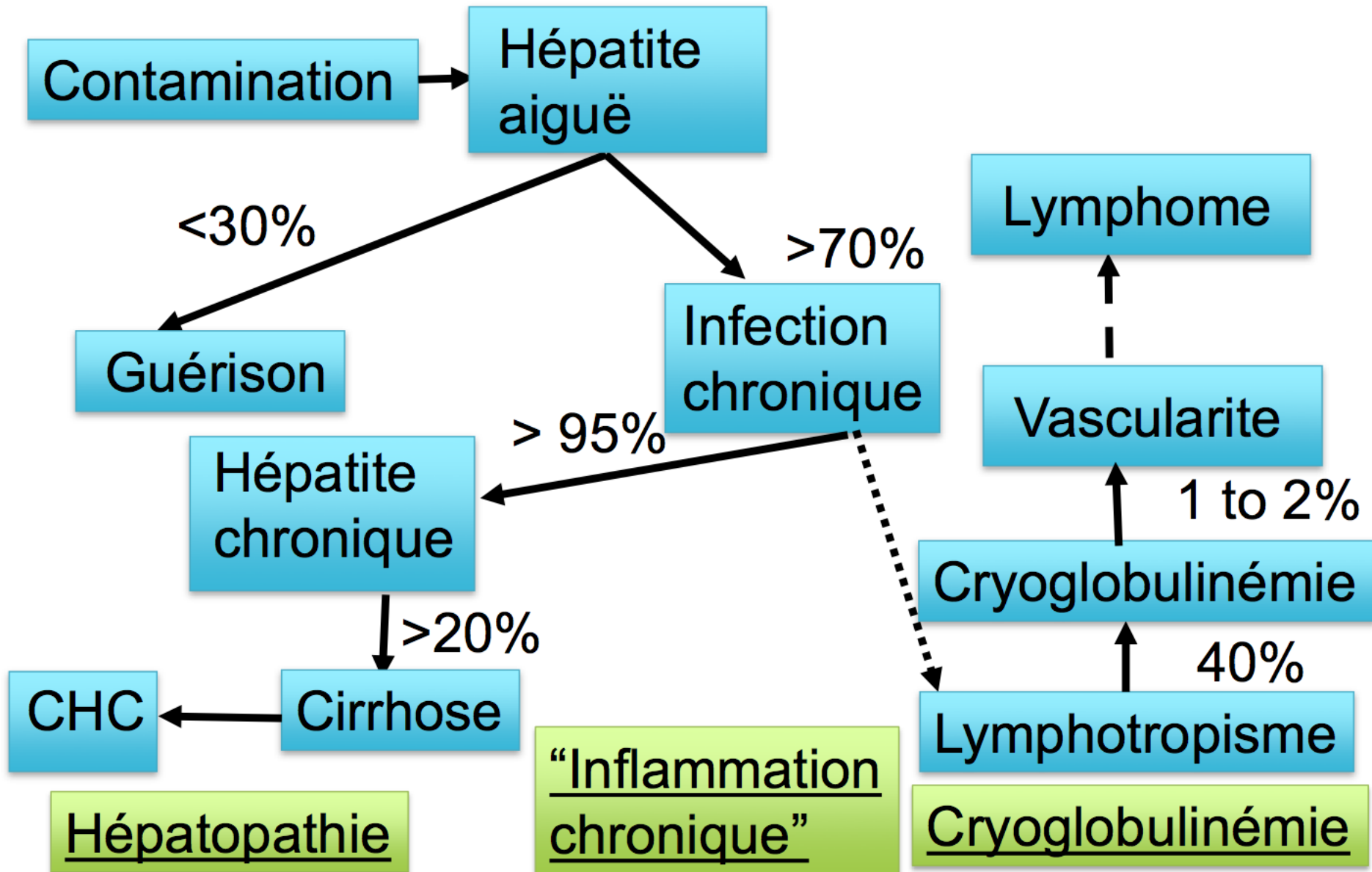

Distribution mondiale

A

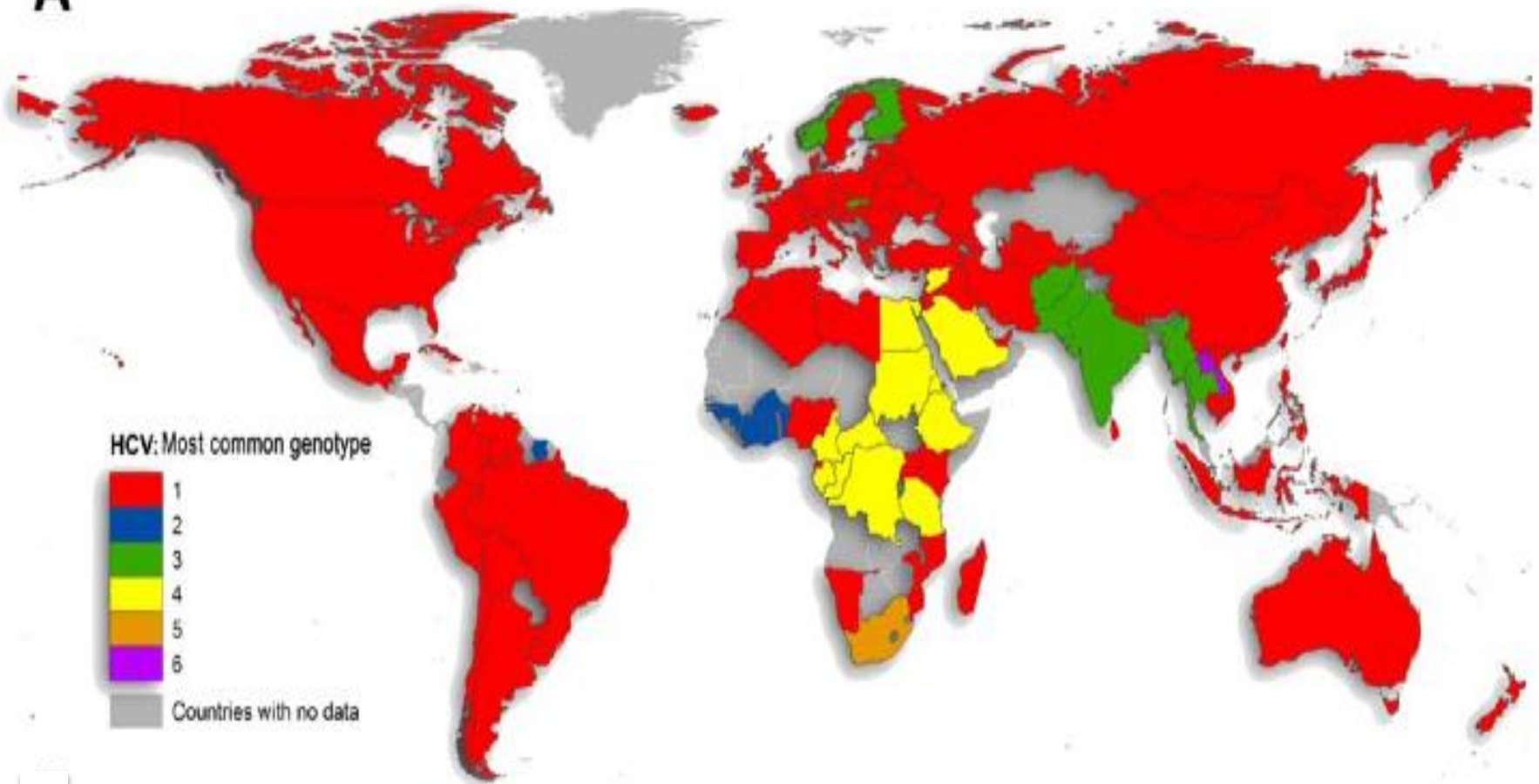

G1 : 47%

G2 : 14%

G3 : 22%

G4 : 15%

HCV worldwide: Limited access to new treatment options in countries with the highest HCV prevalence



Objectif du Traitement ?

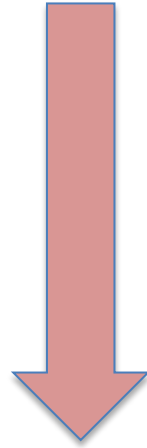

RVS

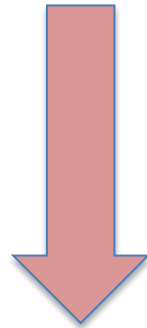

La seule infection chronique curable

L'infection active par le VHC est un facteur de mortalité hépatique et extra-hépatique

Etude de cohorte REVEAL

2 3820 adultes, Taiwan

1 095 sérologie positive; 69,4 % ARN VHC détectable

- Sérologie positive et ARN détectable
- Sérologie positive et ARN indétectable
- Sérologie négative

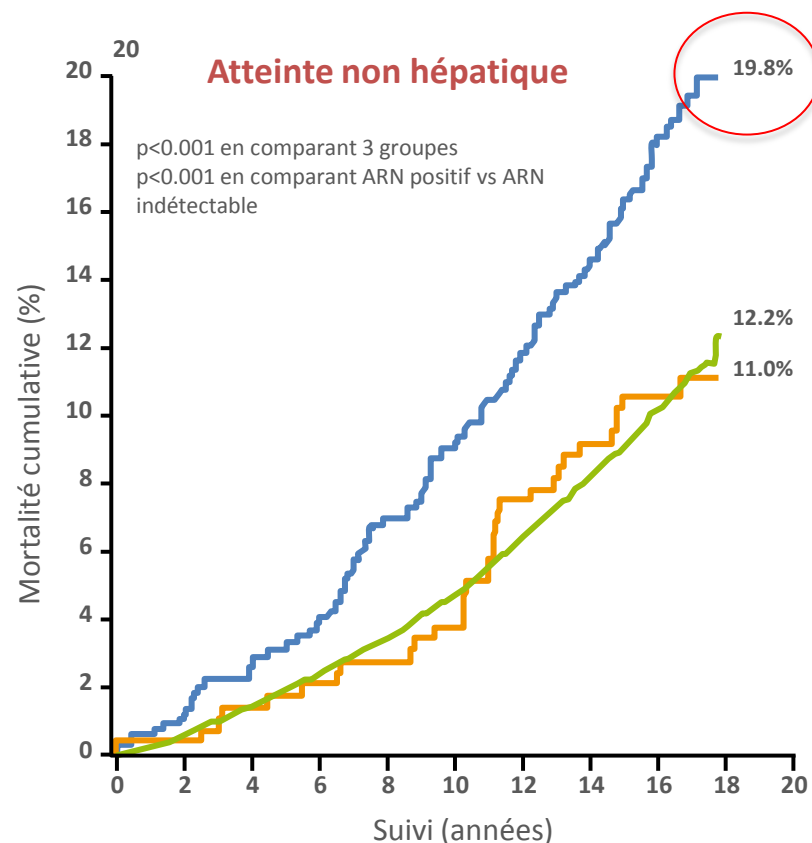
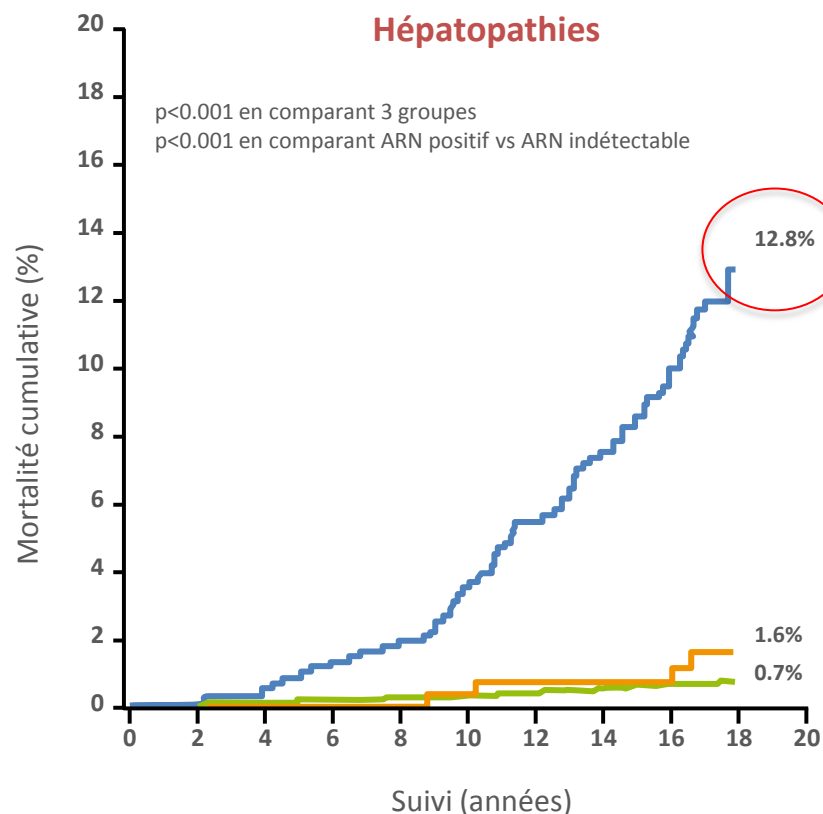

SVR Associated With Reduced 5-Yr Risk of Death and HCC in All Populations

- SVR on IFN-based therapy was associated with substantial benefit vs no SVR
 - 62% to 84% reduction in all-cause mortality, 90% reduction in liver transplantation, 68% to 79% reduction in HCC

5-Yr Risk of All-Cause Death by SVR

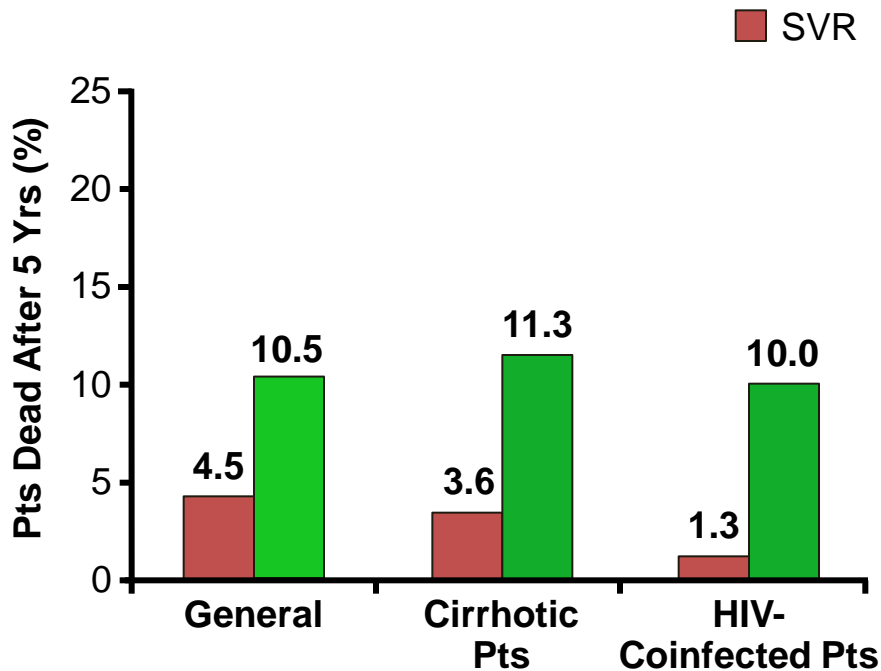

5-Yr Risk of HCC by SVR

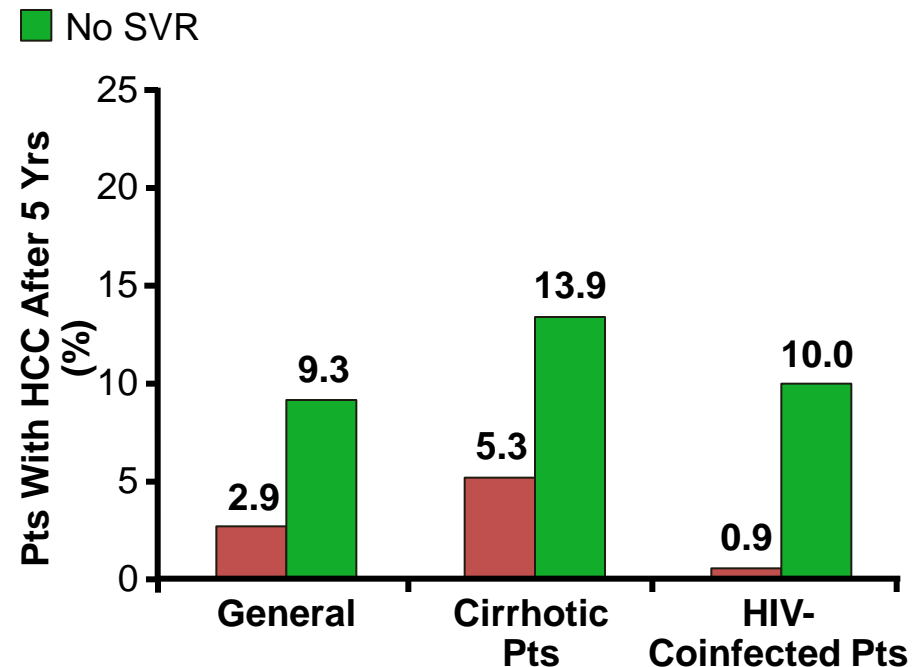

Traitement PEG/Ribavirine

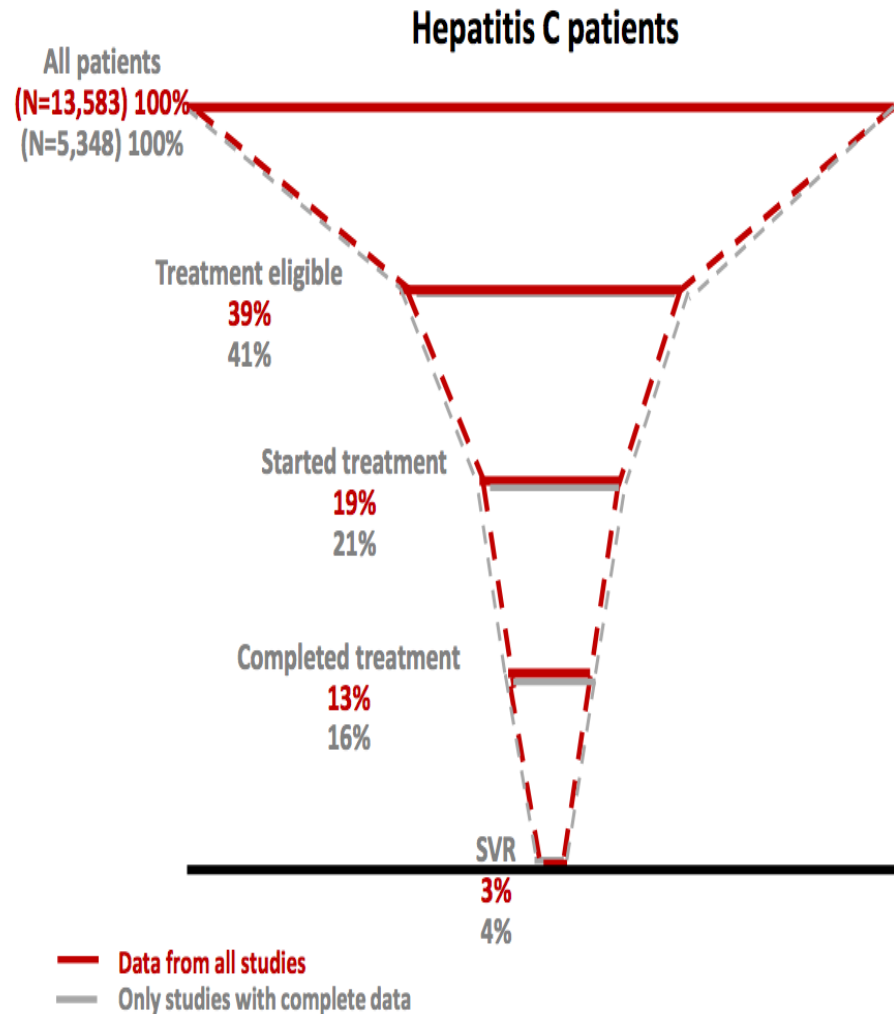

Cycle Viral

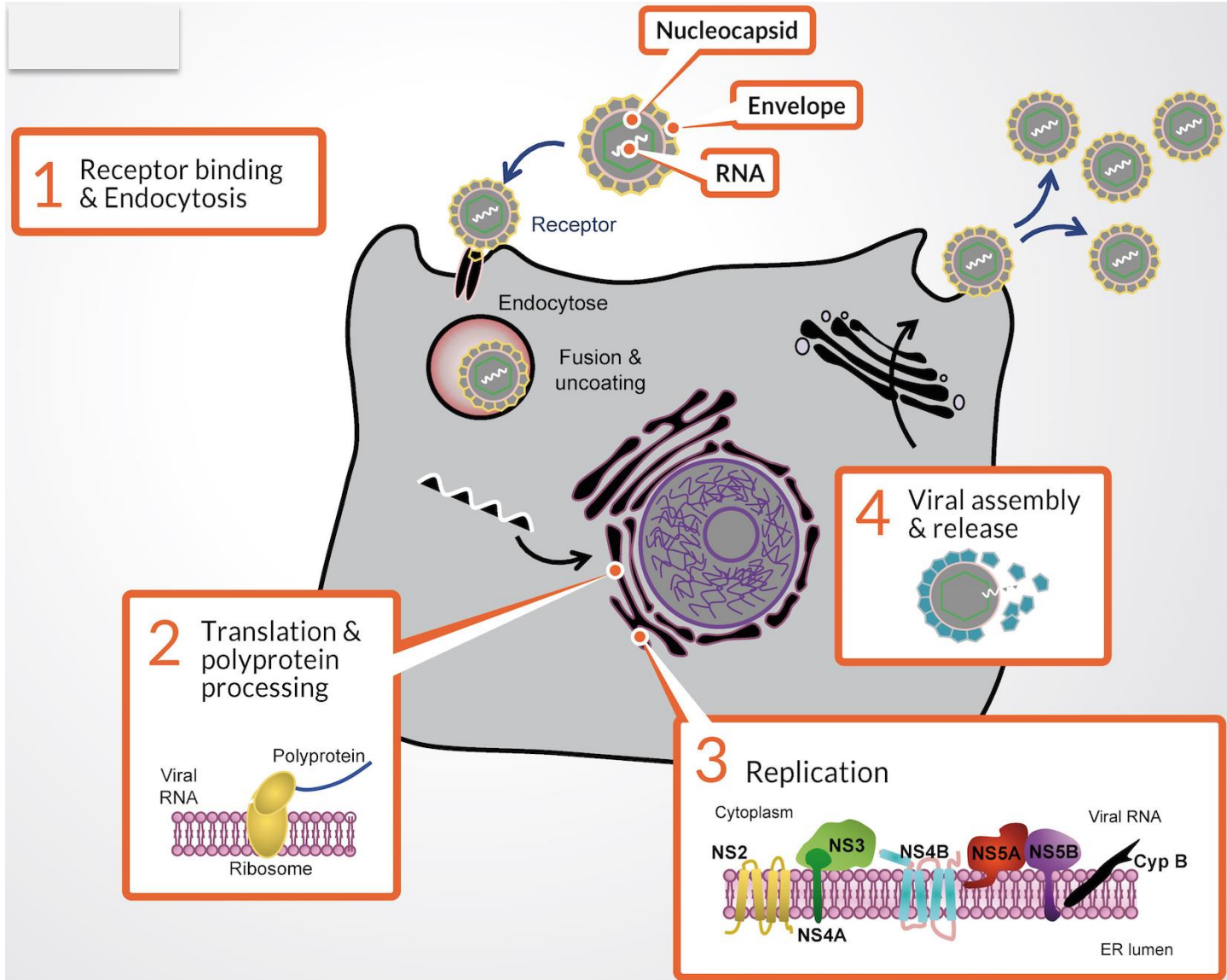

Direct-acting antivirals (DAAs)

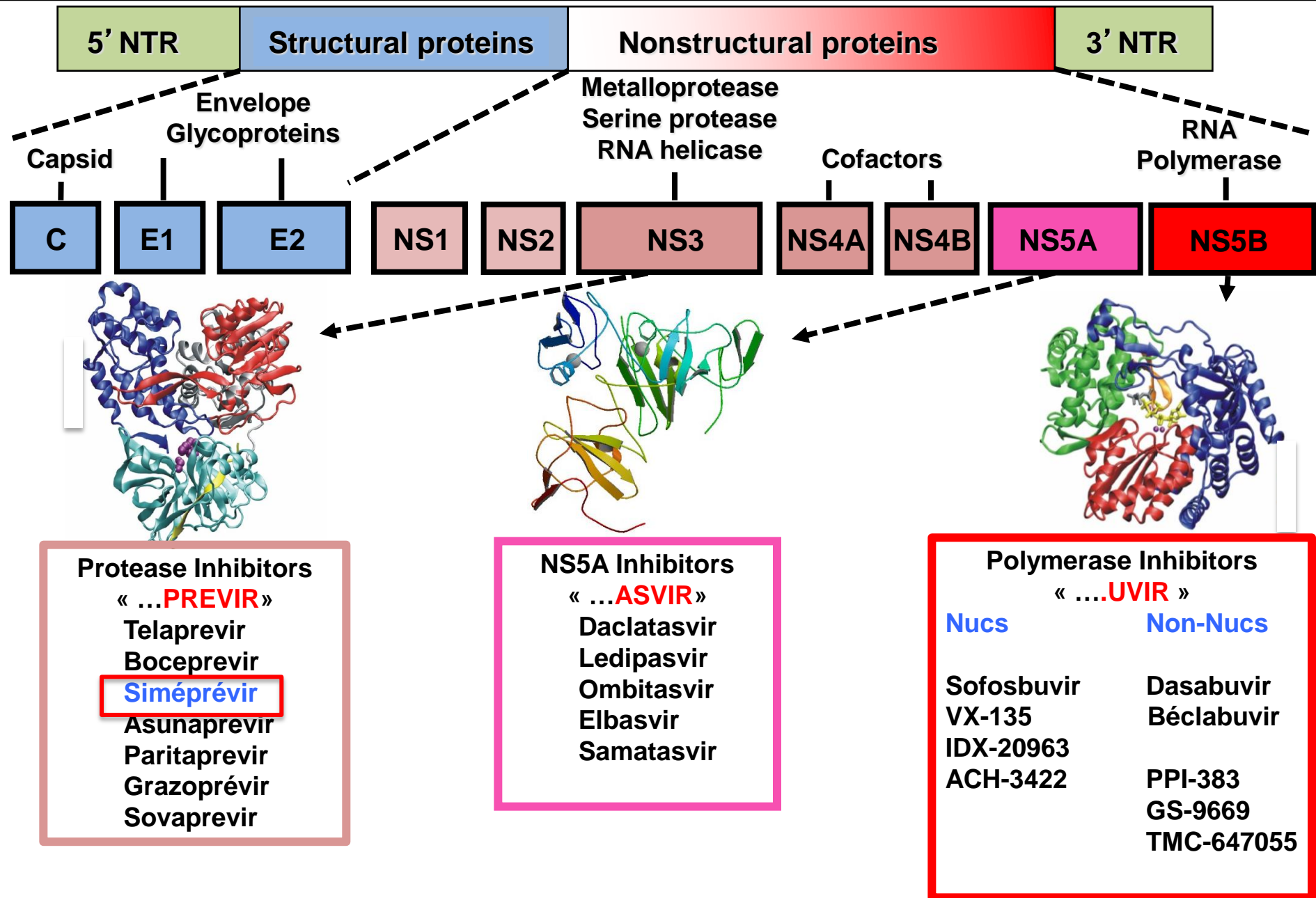

Priorités pour les « Direct-Acting Antivirals »

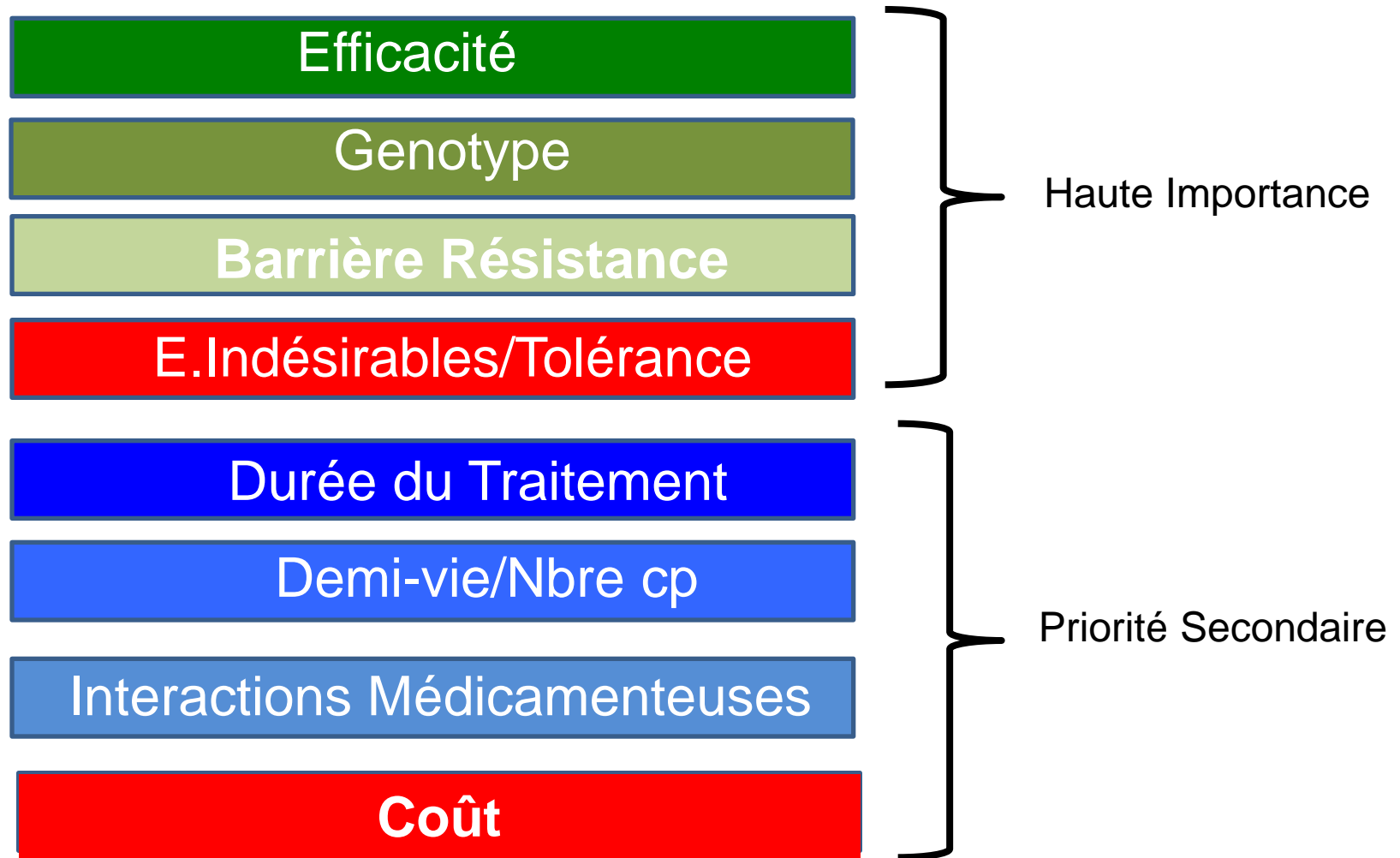

Types de réponse

Definition	Time point	HCV RNA level	Comment
RVR	Week 4	Undetectable	High positive predictive value for SVR
EVR	Week 12	Undetectable: Complete EVR Detectable: Partial EVR $>2 \log_{10}$ drop from baseline Detectable: Null responder $<2 \log_{10}$ drop from baseline	Lack of EVR has very high (>98%) negative predictive value for SVR
eRVR	Week 4, 12	Undetectable	High positive predictive value for SVR with telaprevir- and simeprevir-based triple therapy
Partial response	Week 12+	Partial EVR at week 12 with no subsequent negative HCV RNA test	Treatment failure (pEVR + week 24 HCV RNA detectable, has 100% NPV for SVR)
EOT response	Treatment completion (number of weeks, varies by regimen)	Undetectable	
Relapser	Any time after EOT (usually checked 12 or 24 weeks after EOT)	Undetectable at EOT, detectable after EOT	Treatment failure (relapse >12 weeks after EOT suggests possibility of reinfection; viral sequencing should be considered)
SVR12	Week 60	Undetectable	Predicts SVR24 in monoinfected patients
SVR24	Week 72	Undetectable	Treatment success

Traitement de l'hépatite chronique C

2011

2017

2020

> 2020

RVP

**Combinaison
PEG-IFN – RBV**

DAAs

Traitements avec IFN

**Combinaisons DAAs (IP/I Pol/NS5A)
RBV...**

Traitements sans IFN

>30-98%

Inhibiteurs
Cyclophylline

Inhibiteurs
d'entrée?

Vaccinothérapie?

Cytokines ?
Autres immuno-
modulateurs?

Bi-, Tri-, Quadri-,
Penta-thérapie

Corresponding HCV cure rates

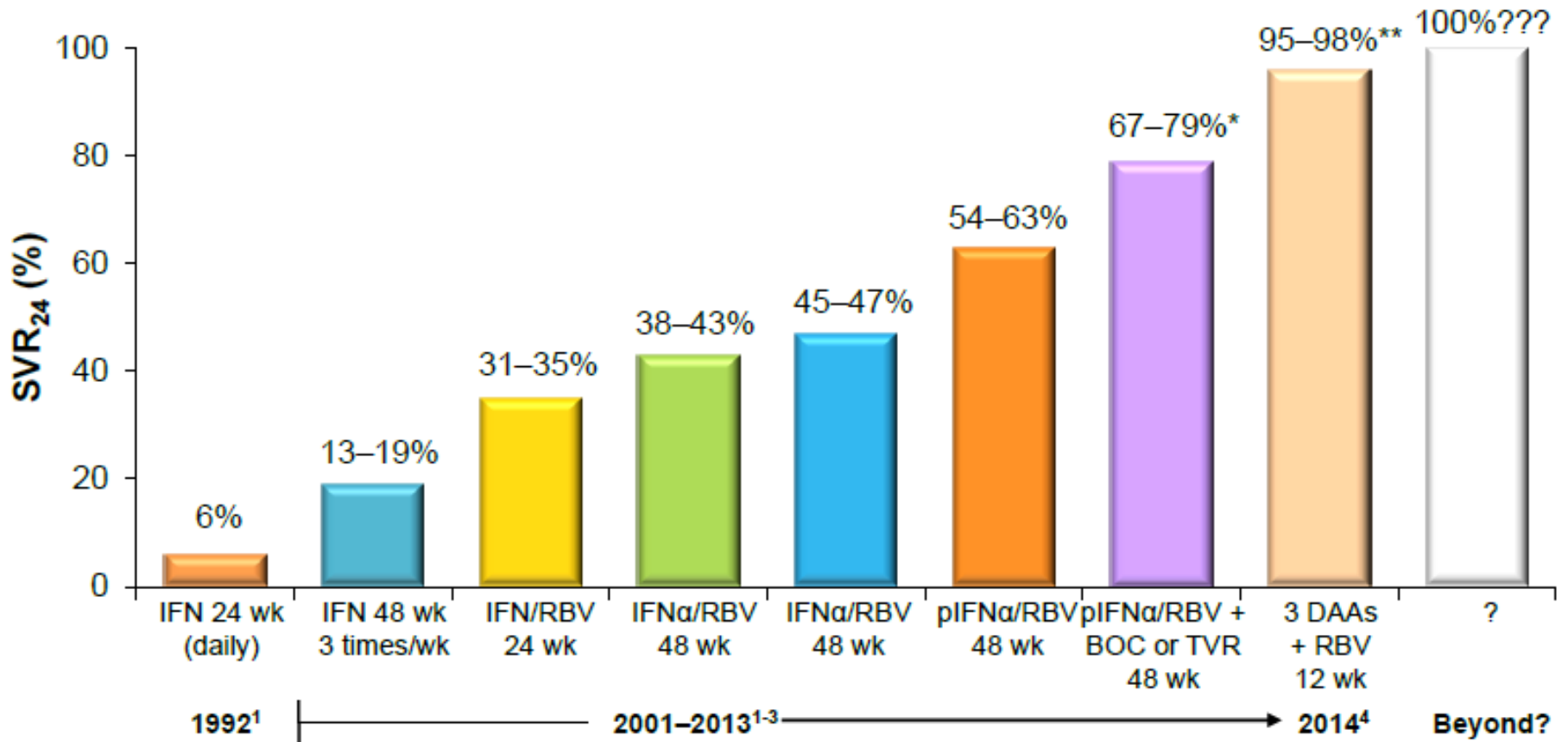

*In patients with HCV genotype 1; ** In treatment-naive patients

2011 – approval of the 1st-generation PIs

The NEW ENGLAND
JOURNAL *of* MEDICINE

ESTABLISHED IN 1812

MARCH 31, 2011

VOL. 364 NO. 13

Boceprevir for Untreated Chronic HCV Genotype 1 Infection

Fred Poordad, M.D., Jonathan McCone, Jr., M.D., Bruce R. Bacon, M.D., Savino Bruno, M.D.,
Michael P. Manns, M.D., Mark S. Sulkowski, M.D., Ira M. Jacobson, M.D., K. Rajender Reddy, M.D.,
Zachary D. Goodman, M.D., Ph.D., Navdeep Boparai, M.S., Mark J. DiNubile, M.D., Vilma Sniukiene, M.D.,
Clifford A. Brass, M.D., Ph.D., Janice K. Albrecht, Ph.D., and Jean-Pierre Bronowicki, M.D., Ph.D.,
for the SPRINT-2 Investigators*

2011 – approval of the 1st-generation PIs

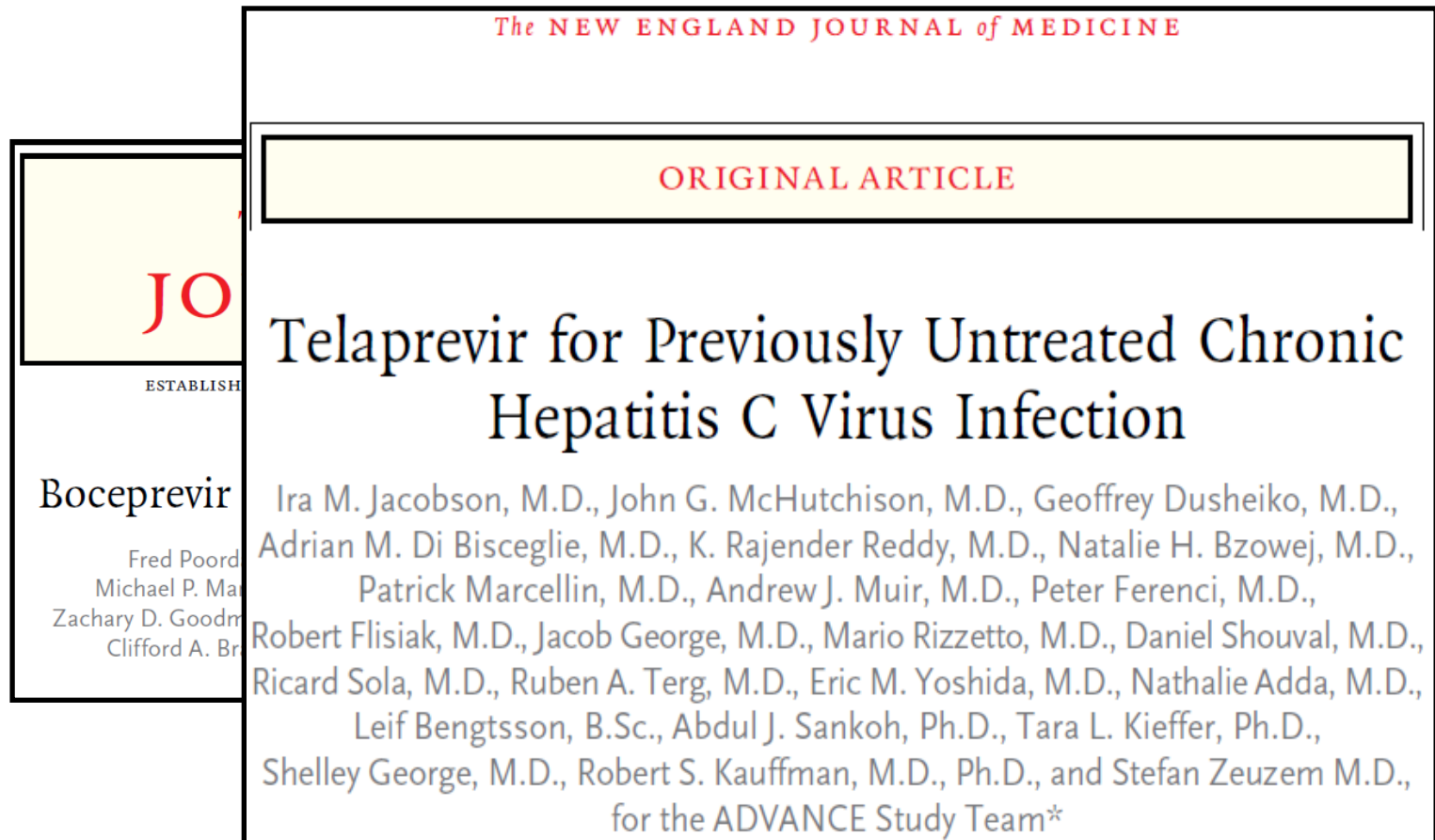

PI = protease inhibitor

Jacobson IM, et al. *N Engl J Med* 2011; **364**:2405–2416;
Poordad F, et al. *N Engl J Med* 2011; **364**:1195–1206.

Efficacité meilleure avec la Trithérapie

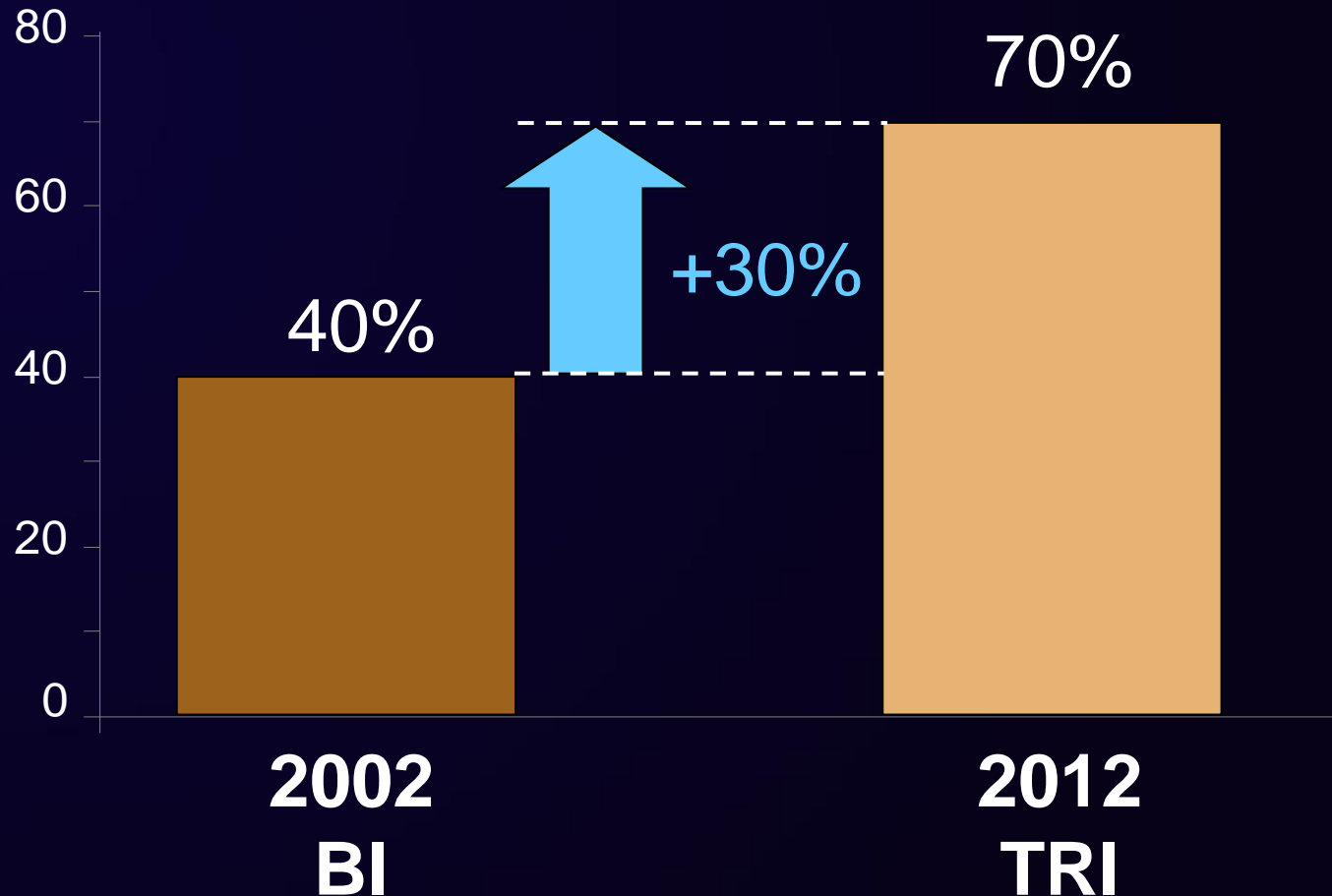

Trithérapie 1st IP : Efficacité fonction de la réponse à l'interféron et du stade de la Fibrose

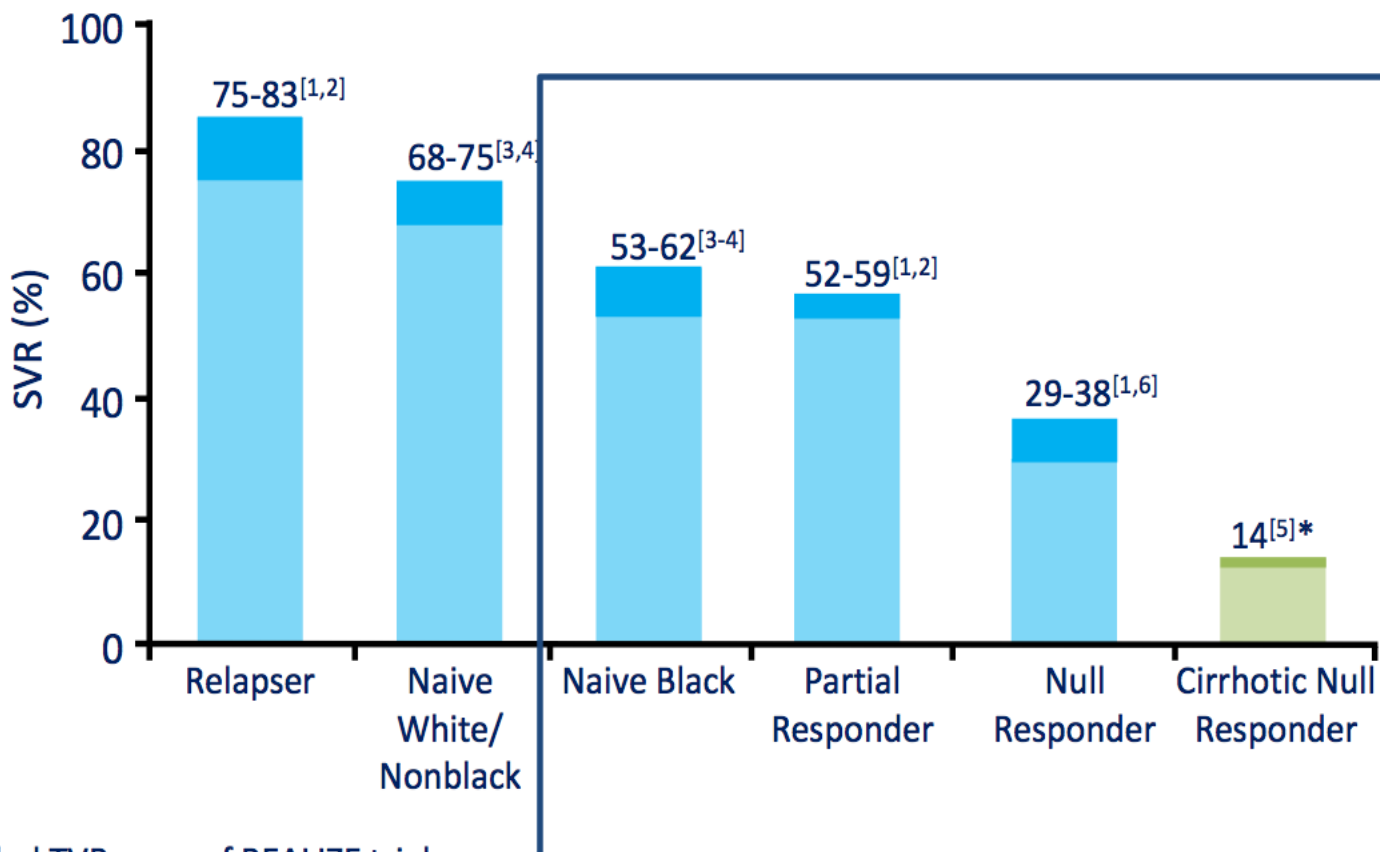

*Pooled TVR arms of REALIZE trial.

1. Zeuzem S, et al. N Engl J Med. 2011;364:2417-2428.
2. Bacon BR, et al. N Engl J Med. 2011;364:1207-1217.
3. Jacobson IM, et al. N Engl J Med. 2011;364:2405-2416.
4. Poordad F, et al. N Engl J Med. 2011;364:1195-1206.
5. Zeuzem S, et al. EASL 2011. Abstract 5.
6. Vierling JM, et al. AASLD 2011. Abstract 931.

1st-generation PIs + PegIFN alfa + RBV: High frequency of side effects

Adverse events¹⁻³

- Anemia
- Rash/dysgeusia
- Many SAEs in patients with cirrhosis

International guidelines^{4,5}
do not recommend the use of
BOC or TVR + PegIFN/RBV for
patients with HCV GT1 infection

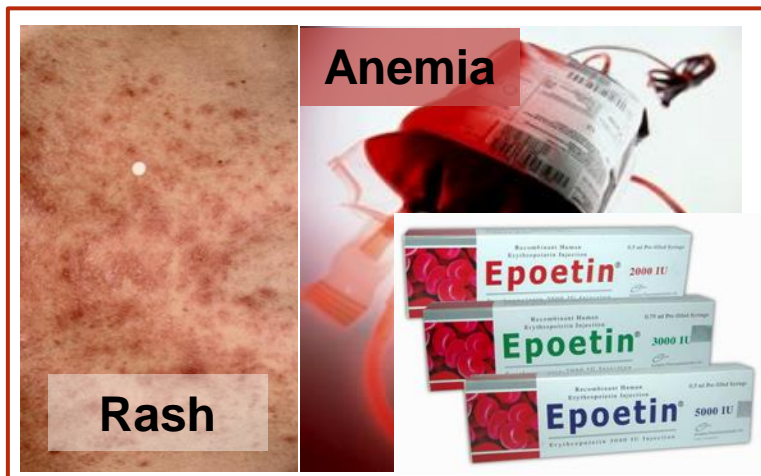

- 1. Hézode C, *et al. J Hepatol* 2013; **59**:434–41; 2. Colombo M, *et al. Gut* 2013; DOI: 10.1136/gutjnl-2013-305667; 3. Maasoumy B, *et al. PLoS One* 2013; **8**:e55285; 4. AASLD hepatitis C guidelines; 5. EASL hepatitis C guidelines

SIMEPREVIR (TMC 435)

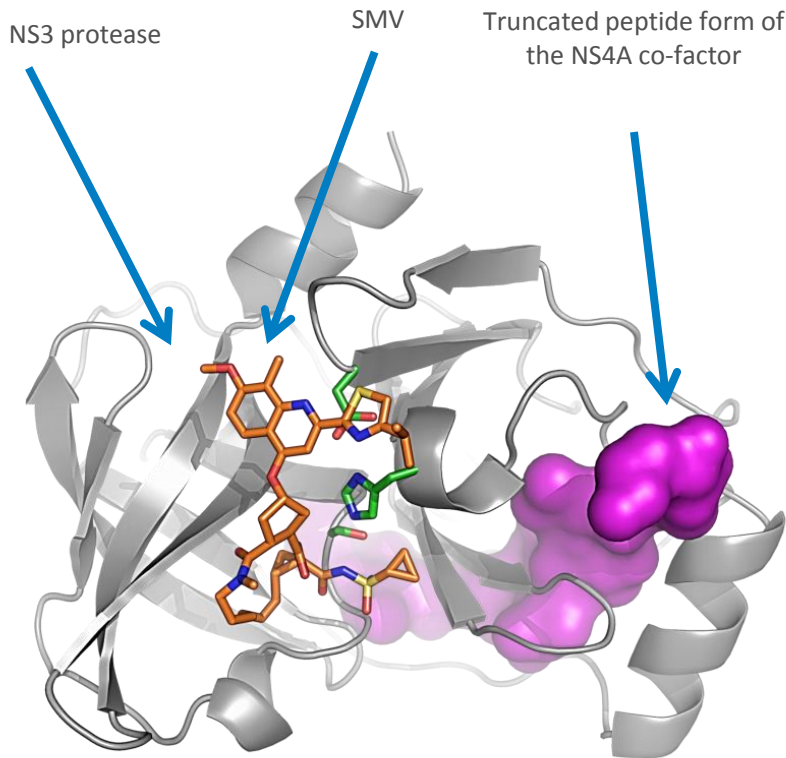

Inhibiteur protéase NS3/4A

Activité Antivirale chez les patients avec VHC
GT 1, 2, 4, 5, et 6¹⁻⁴

3D crystal structure of SMV bound to its therapeutic target (HCV NS3/4A protease enzyme)

1. Reesink HW et al. Gastroenterology 2010;138:913-21;
2. Moreno C et al. J Hepatol. 2012;56:1247-53;
3. Zeuzem S et al. Gastroenterology 2014;146:430-41;
4. Fried MW et al. Hepatology 2013;58:1918-25.
5. Jacobson I et al. EASL 2013; 6. Manns M et al. EASL 2013;
7. Fornis X, et al. Gastroenterol 2014; 146: 1669-79
8. Moreno, C et al. EASL 2014. Poster 1319

Simeprevir: mécanisme d'action

Organisation du génome VHC Traduction et maturation de la polyprotéine

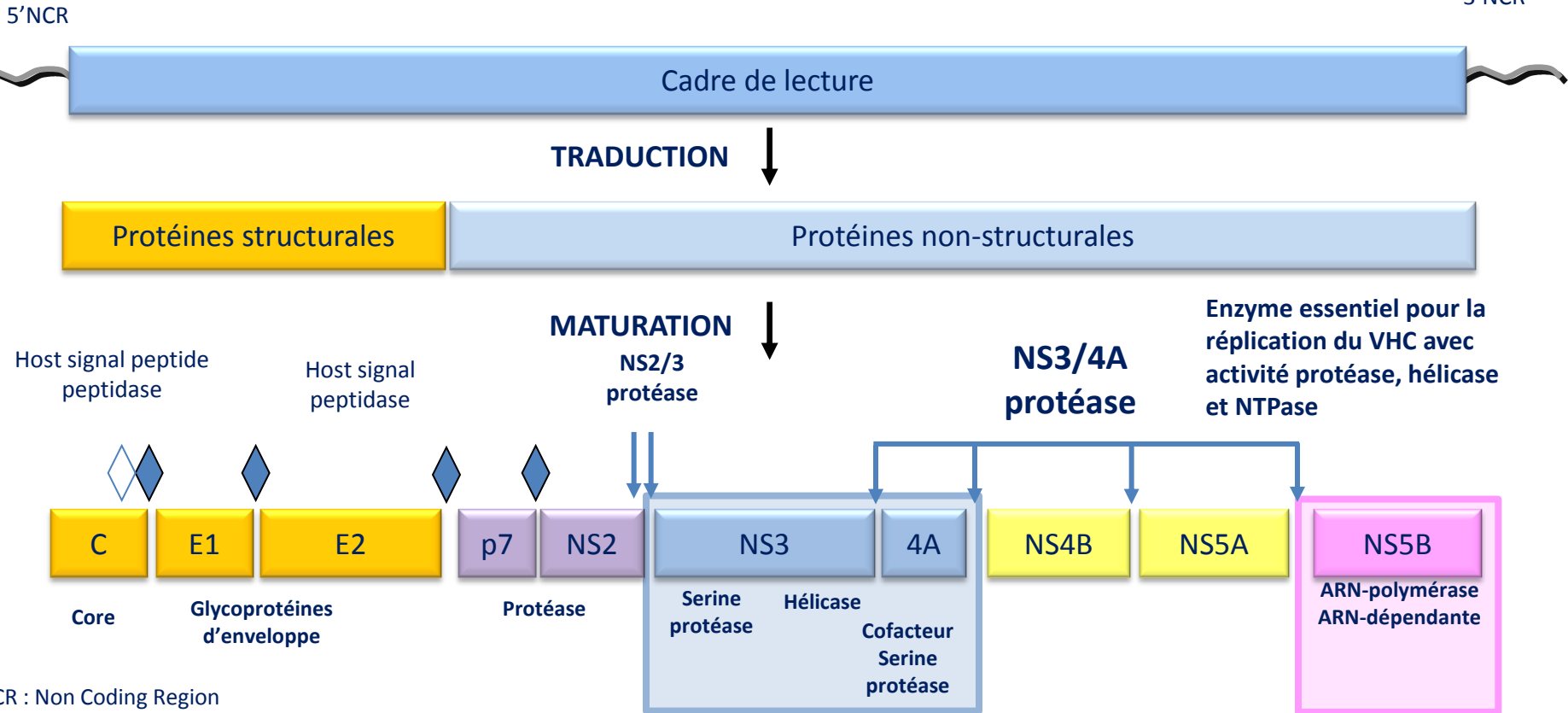

Treatment Naïve

Simeprevir + PEG + RBV in Treatment-Naïve Genotype 1 QUEST-1 Trial

Jacobson IM, et al. *Lancet*. 2014;384:403-13.

QUEST-1 Trial: Features

- **Design:** Randomized, double-blind, placebo-controlled, phase 3 trial with simeprevir + PEG + RBV versus PEG + RBV in treatment-naïve GT 1
- **Setting:** Multicenter at 71 sites in 13 countries
- **Entry Criteria**
 - Treatment-naïve, chronic HCV mono-infection
 - HCV Genotype 1 (1a or 1b)
- **Patient Characteristics**
 - **N = 394**
 - HCV Genotype: 1a (56%); 1b (44%)
 - IL28B Genotype: 71% non-CC
 - Age: median age 48
 - Sex: 56% male
 - Race: 89% white, 8% black
 - Liver disease: F3 = 18%; F4 = 12%
- **Primary end-points:** Efficacy (SVR12) and safety

QUEST-1 Trial: Design

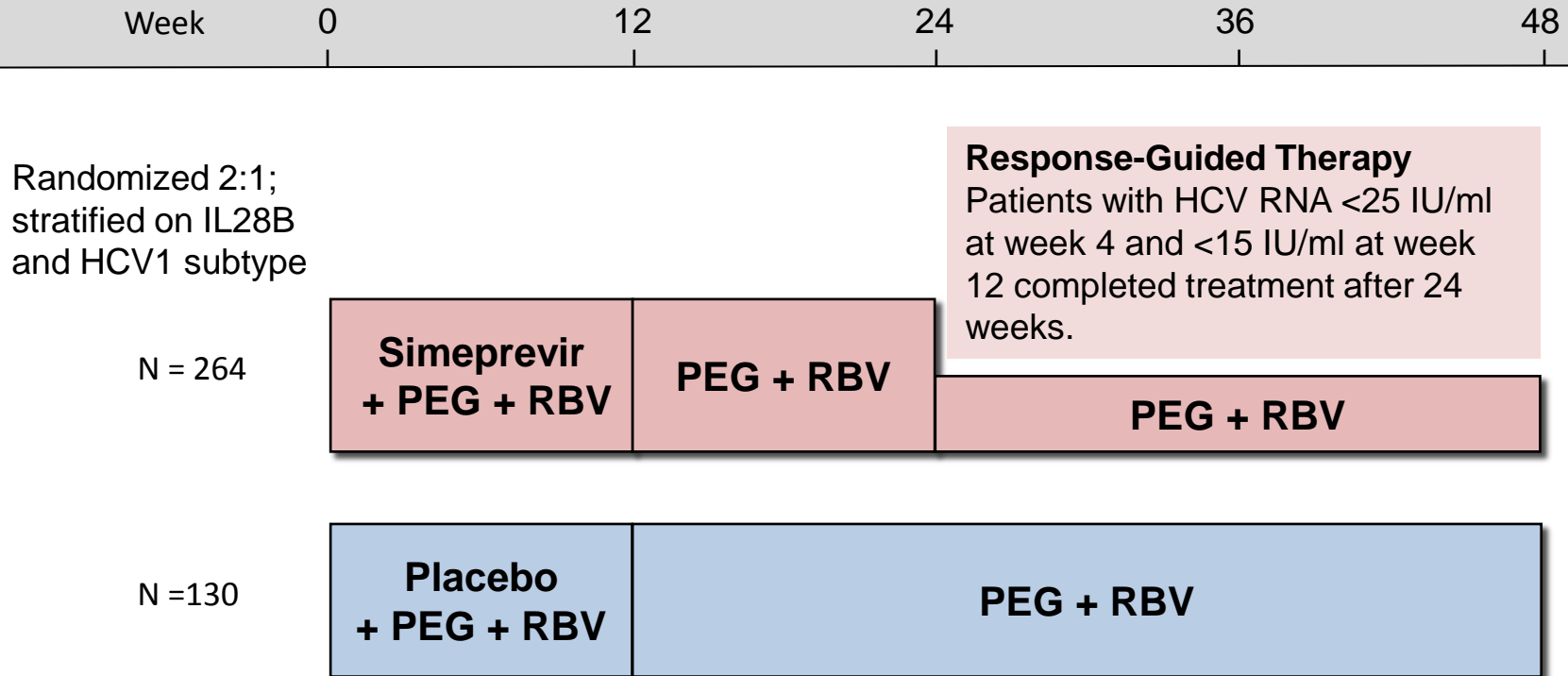

Drug Dosing

Simeprevir: 150 mg once daily

Peginterferon alfa-2a (PEG): 180 mcg/week

Ribavirin (RBV) weight-based (in 2 divided doses): 1000 mg/day if < 75 kg or 1200 mg/day if ≥ 75kg

QUEST-1 Trial: Results

QUEST-1: Proportion of Patients with SVR12

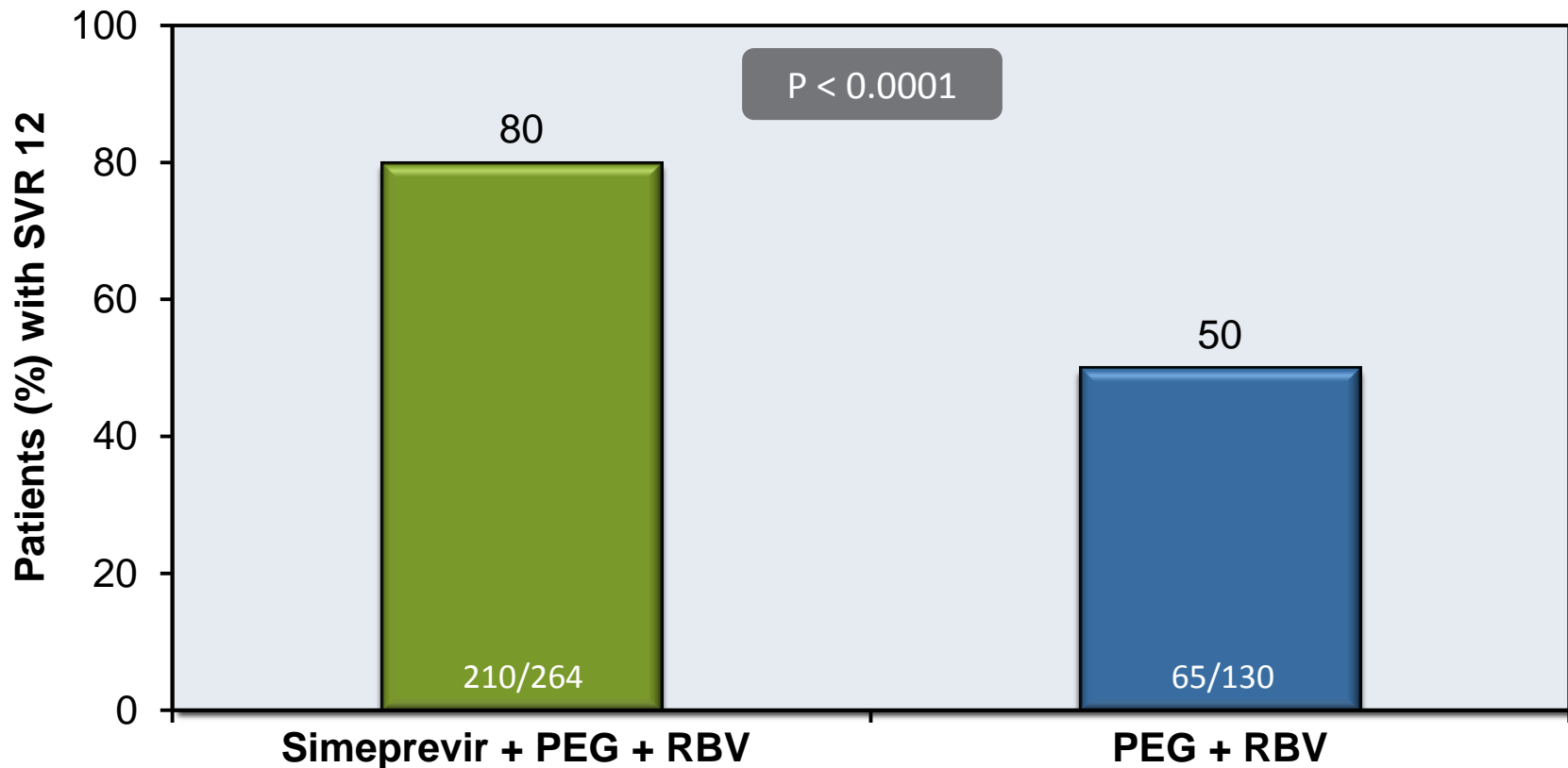

Abbreviations: SVR12 = sustained virologic response at 12 weeks; PEG = peginterferon; RBV = ribavirin

QUEST-1 Trial: Results

SVR12 by HCV Genotype 1 Subtype

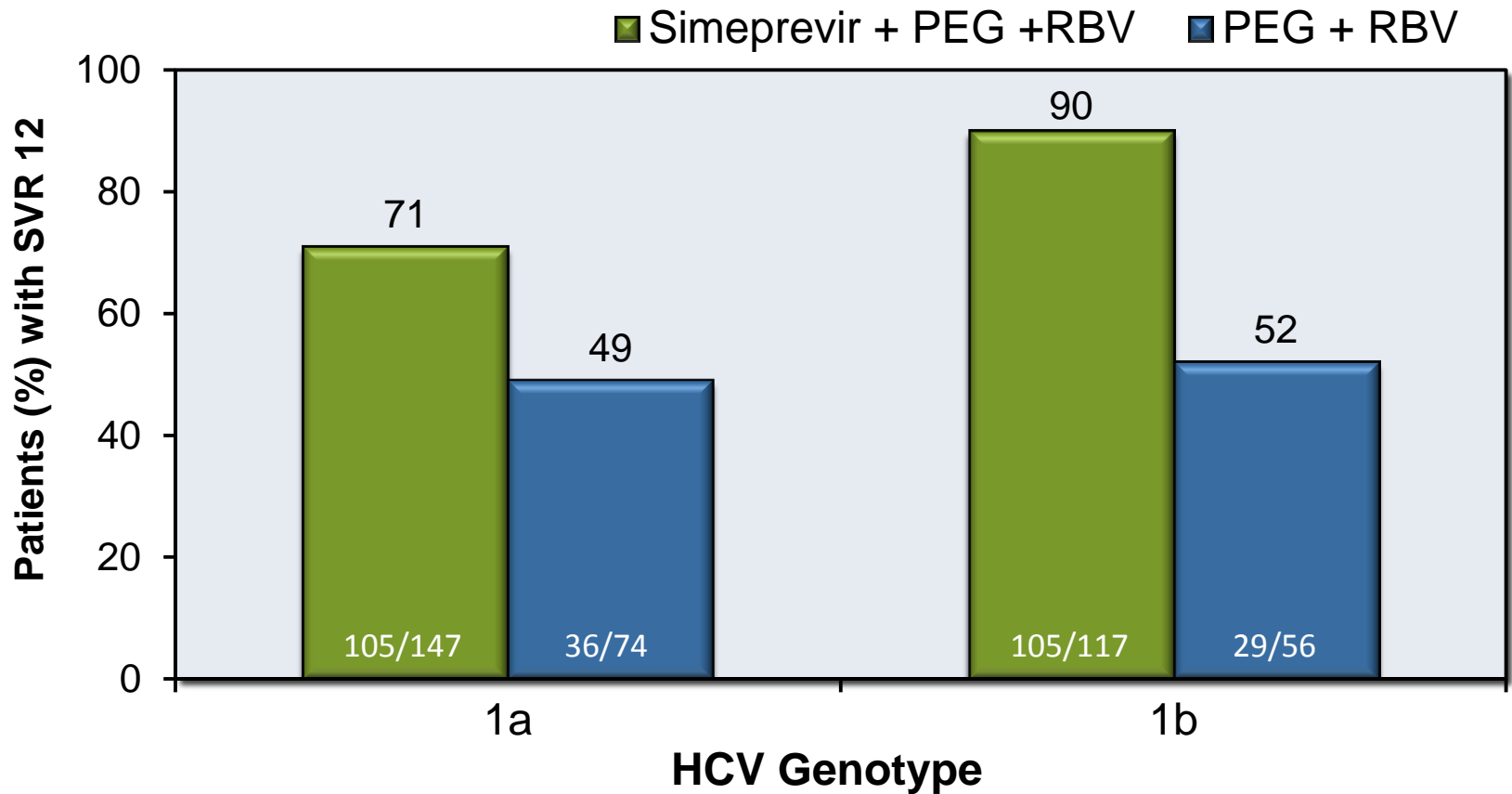

Abbreviations: PEG = Peginterferon RBV = Ribavirin

QUEST-1 Trial: Results

SVR12 Response in Simeprevir Arm Based on Achievement of RGT Criteria

Patients (%) who Met RGT Criteria

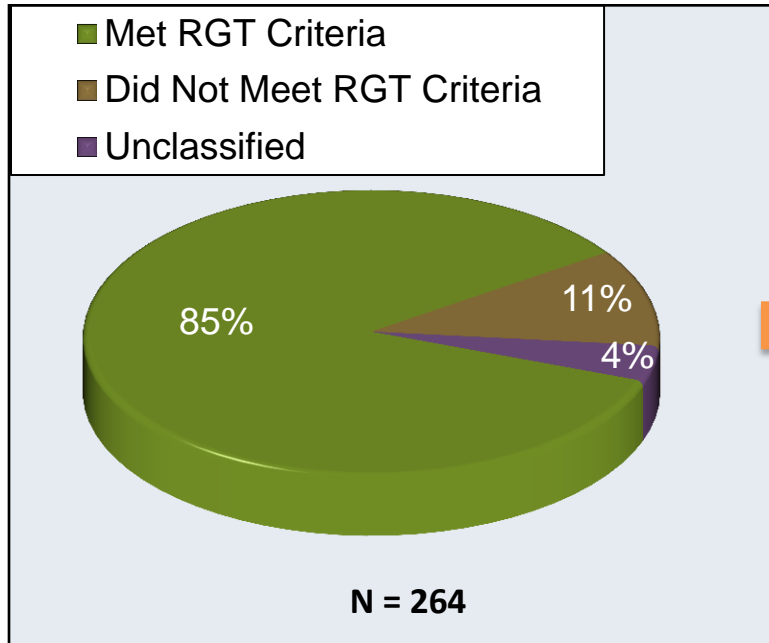

SVR12 Based on Meeting RGT

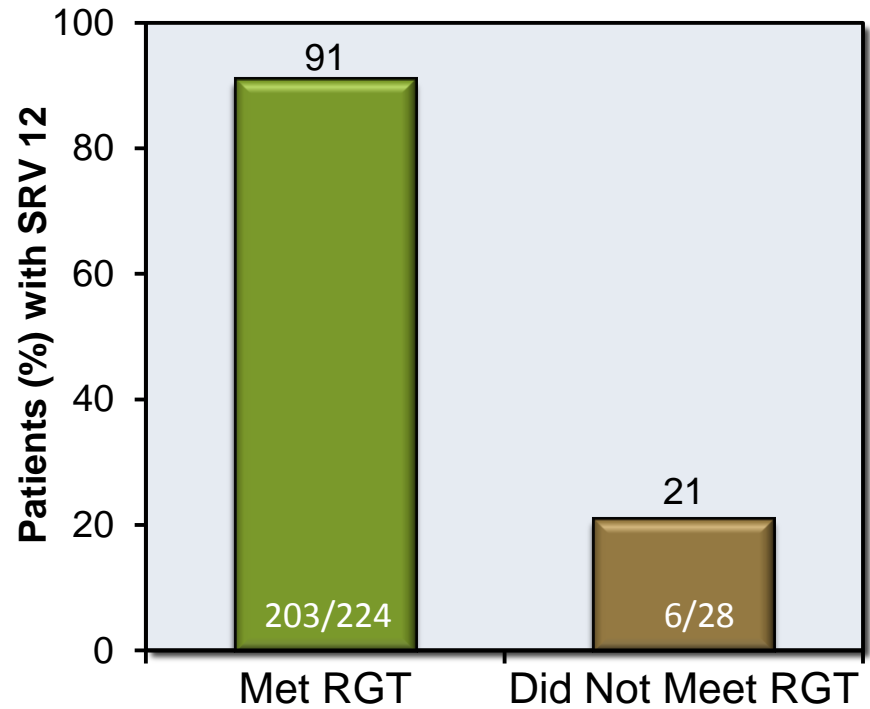

RGT= response-guided therapy: in simeprevir study arm, patients with HCV RNA<25 IU/ml at week 4 (undetectable or detectable) and <25 IU/ml at week 12 (undetectable) stopped treatment after 24 weeks

Treatment Naïve

Simeprevir + PEG + RBV in Treatment-Naïve Genotype 1 QUEST-2 Trial

Manns M, et al. Lancet 2014;384:414-26

QUEST-2 Trial: Features

- **Design:** Randomized, double-blind, placebo-controlled, phase 3 trial of simeprevir + PEG + RBV versus PEG + RBV in HCV GT1
- **Setting:** Multicenter at 76 sites in 14 countries
- **Entry Criteria**
 - Treatment-naïve, chronic HCV mono-infection
 - HCV Genotypes 1a or 1b
- **Patient Characteristics**
 - **N = 391**
 - HCV Subtype: 1a (41%); 1b (58%)
 - IL28B Genotype: 30% CC
 - Age and Sex: median age 46; 55% male
 - Race: 92% white
 - Liver disease: 14% with F3; 6% with F4
- **Primary end-points:** Efficacy (SVR12) and safety

QUEST-2 Trial: Design

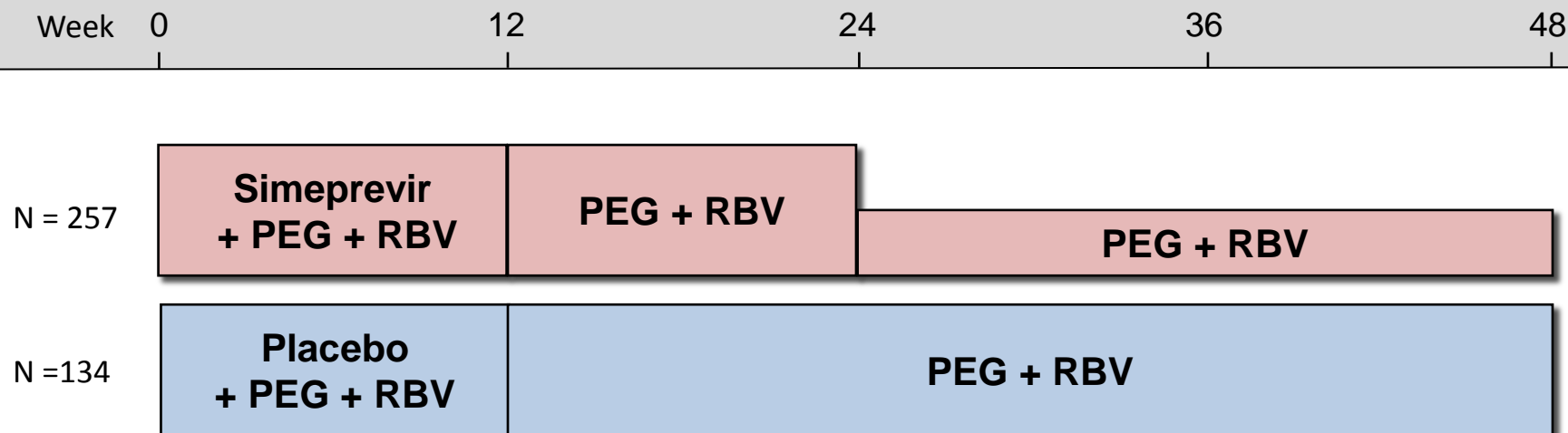

Study Notes

- Randomized 2:1, stratified on IL28B and HCV subtype
- 63% in each arm randomized to receive PEG alfa-2a or PEG alfa-2b; remainder assigned PEG alfa-2a
- Response-guided therapy (RGT): In simeprevir study arm, patients with HCV RNA < 25 IU/ml at week 4 (undetectable or detectable) and < 25 IU/ml at week 12 (undetectable) stopped treatment after 24 weeks

Drug Dosing

Simeprevir: 150 mg once daily

Peginterferon alfa-2a (PEG): 180 mcg/week OR Peginterferon alfa-2b: 1.5 mcg/kg/week

Ribavirin (RBV) weight-based (in 2 divided doses): 1000 mg/day if < 75 kg or 1200 mg/day if ≥ 75 kg

QUEST-2 Trial: Results

QUEST 2: Proportion of Patients with SVR12

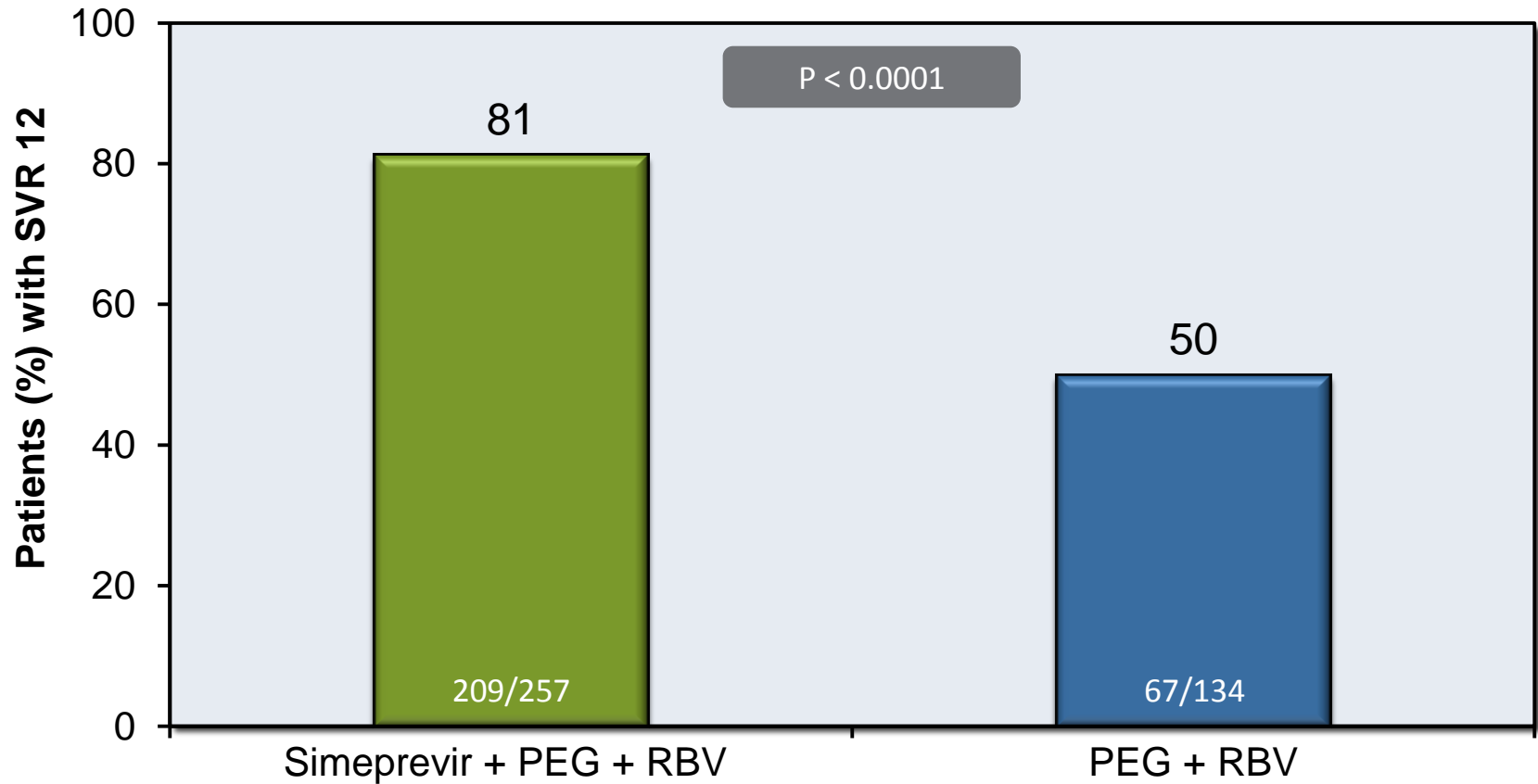

Abbreviations: SVR12 = sustained virologic response at 12 weeks; PEG = peginterferon; RBV = ribavirin

QUEST-2 Trial: Results

QUEST 2: SVR12 by HCV Genotype 1 Subtype

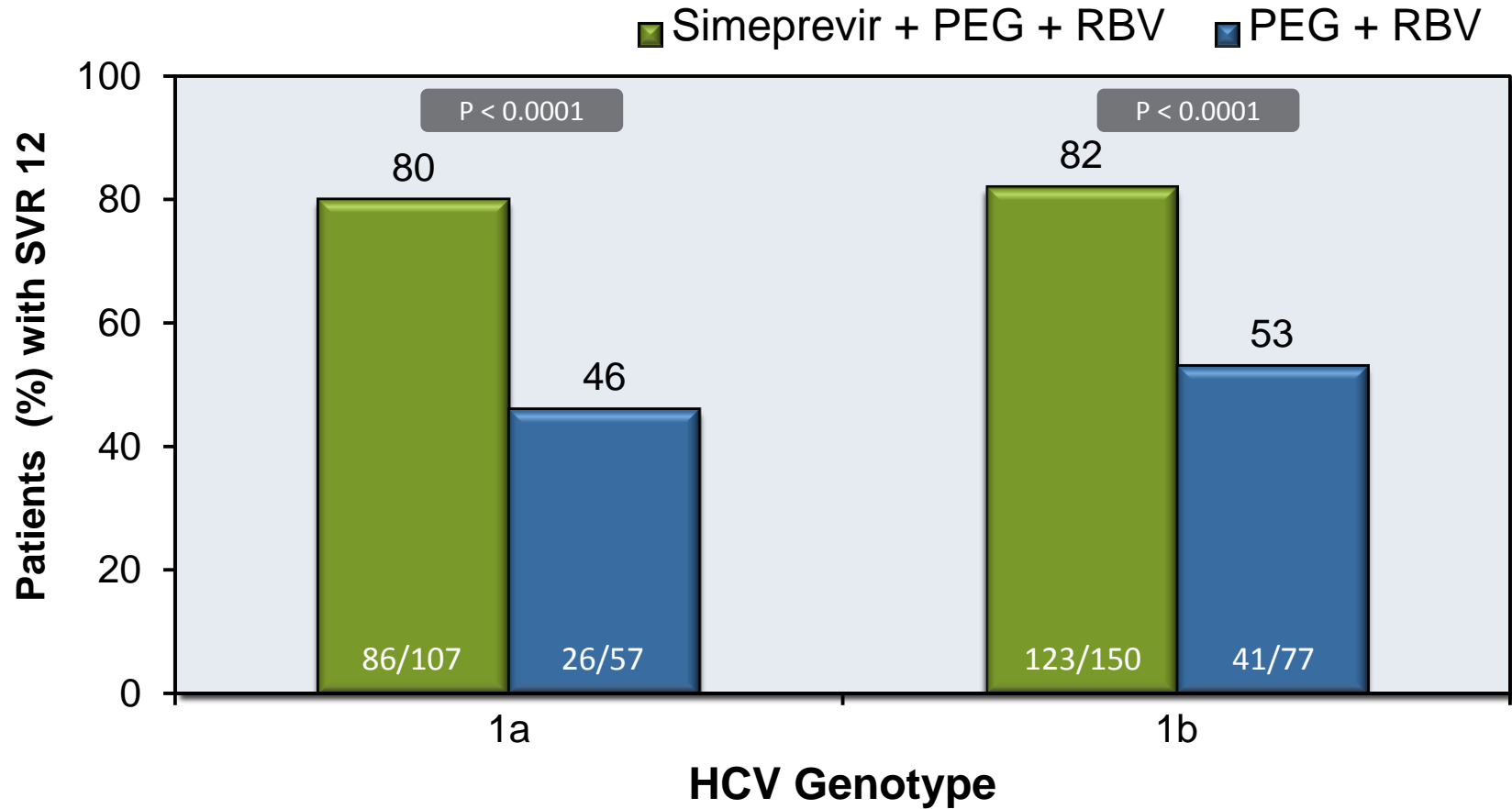

Abbreviations: SVR12 = sustained virologic response at 12 weeks; PEG = peginterferon; RBV = ribavirin

QUEST-2 Trial: Results

QUEST 2: SVR12 Response in Simeprevir Arm Based on RGT Criteria

Patients (%) who Met RGT Criteria

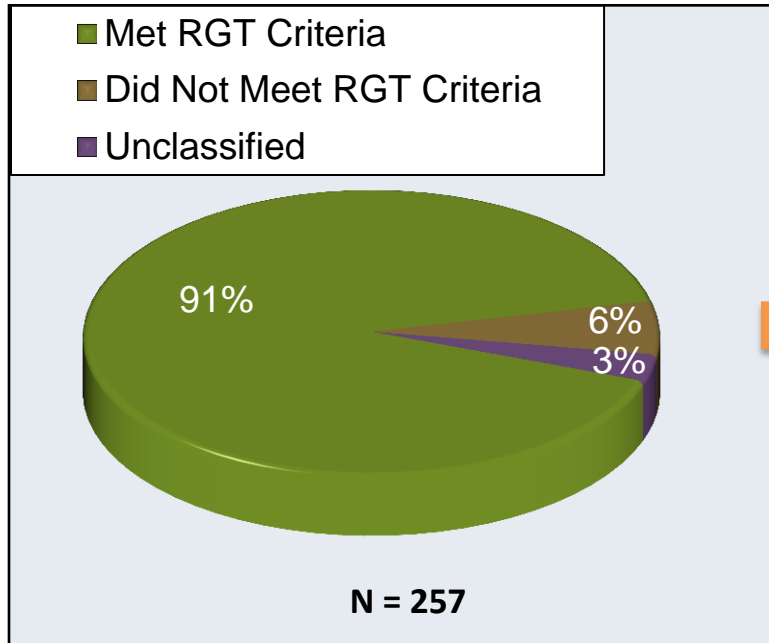

SVR 12 Based on Meeting RGT

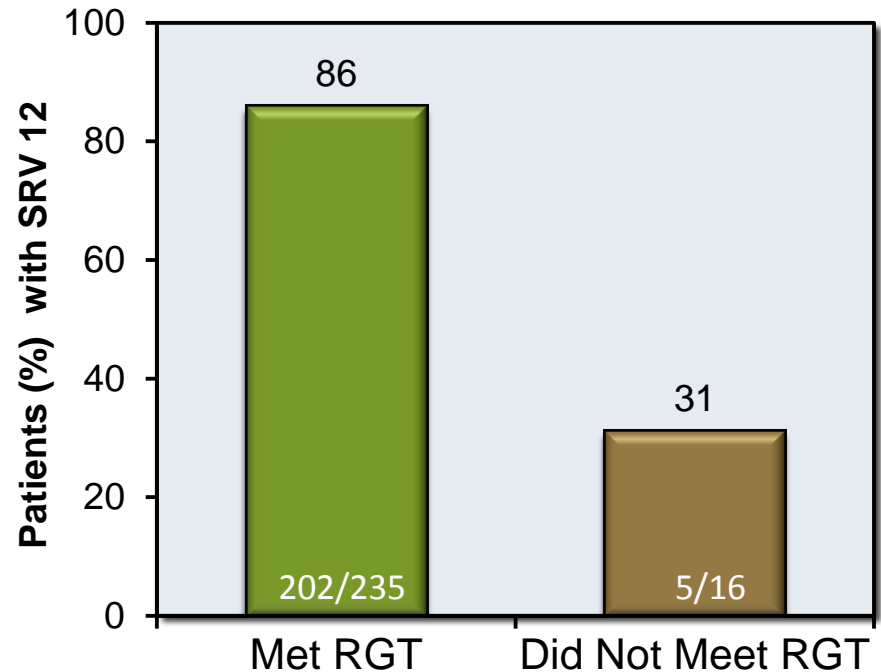

RGT= response-guided therapy: in simeprevir study arm, patients with HCV RNA<25 IU/ml at week 4 (undetectable or detectable) and <25 IU/ml at week 12 (undetectable) stopped treatment after 24 weeks

SMV + PR : Pooled Quest 1 et 2

RVS en fct Fibrose

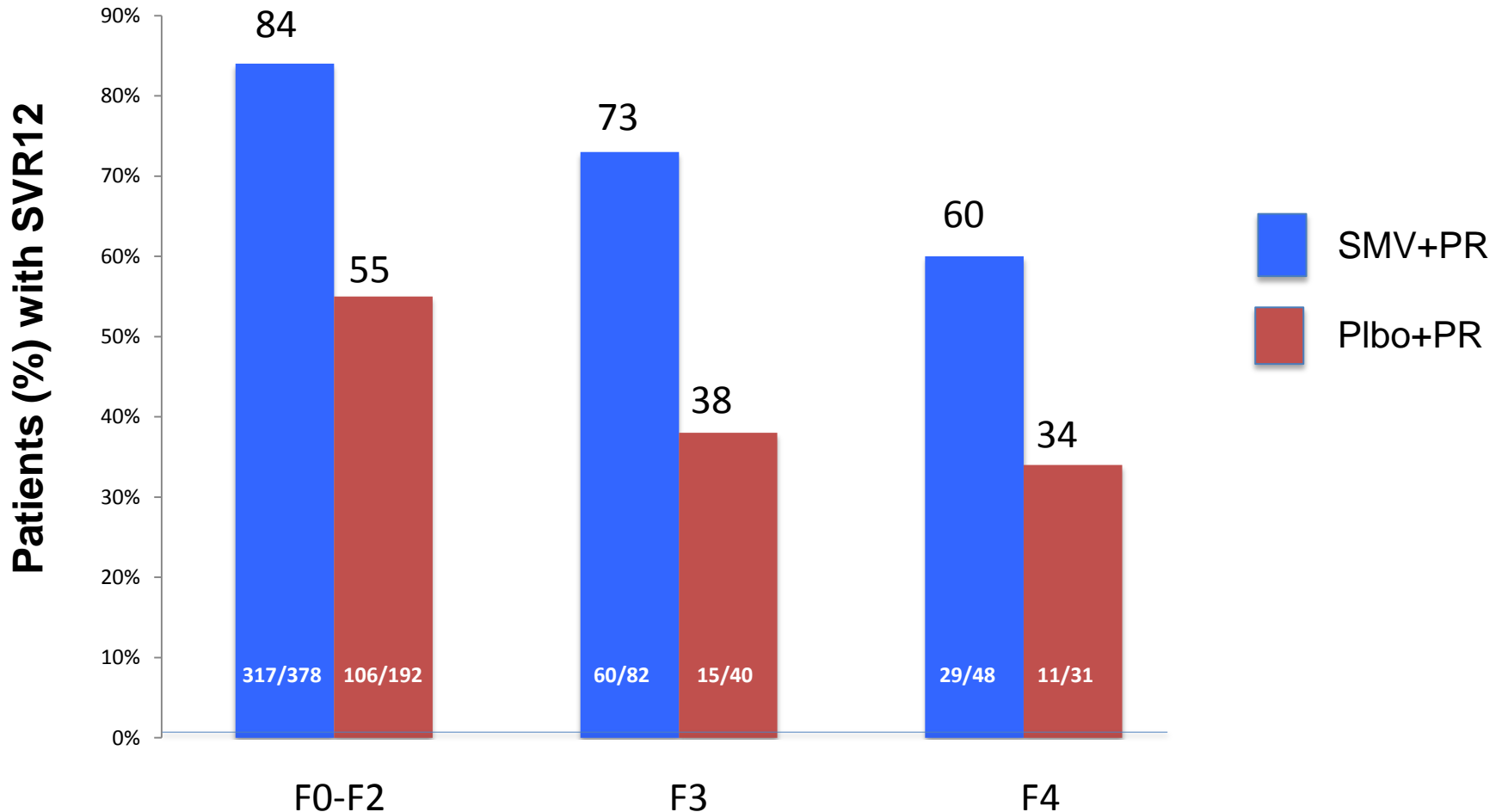

SMV + PR : Pooled Quest 1 et 2

RVS en Fct *IL-28b*

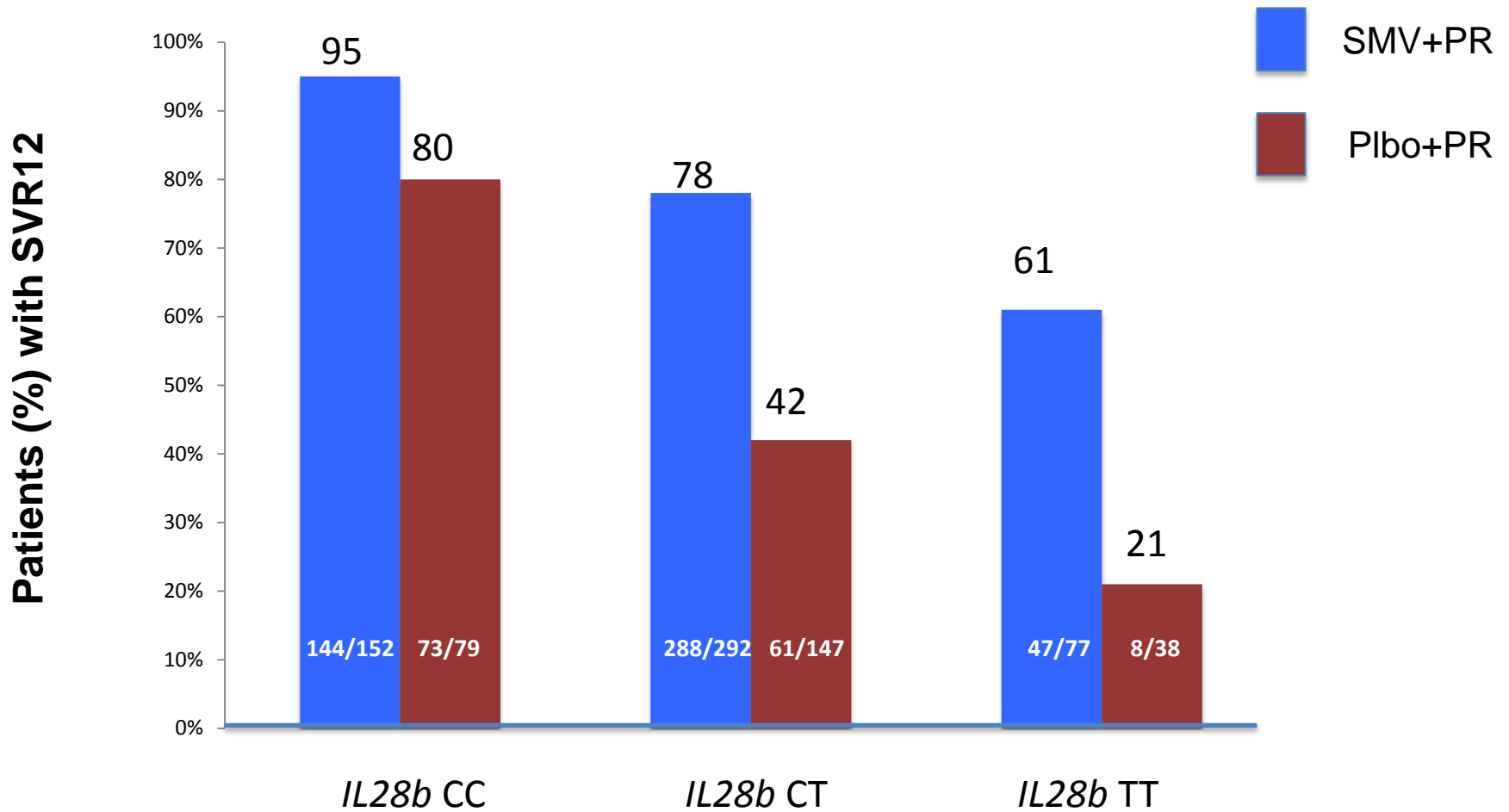

SMV + PR : Pooled Quest 1 et 2

RVS en Fct du génotype et Q80K

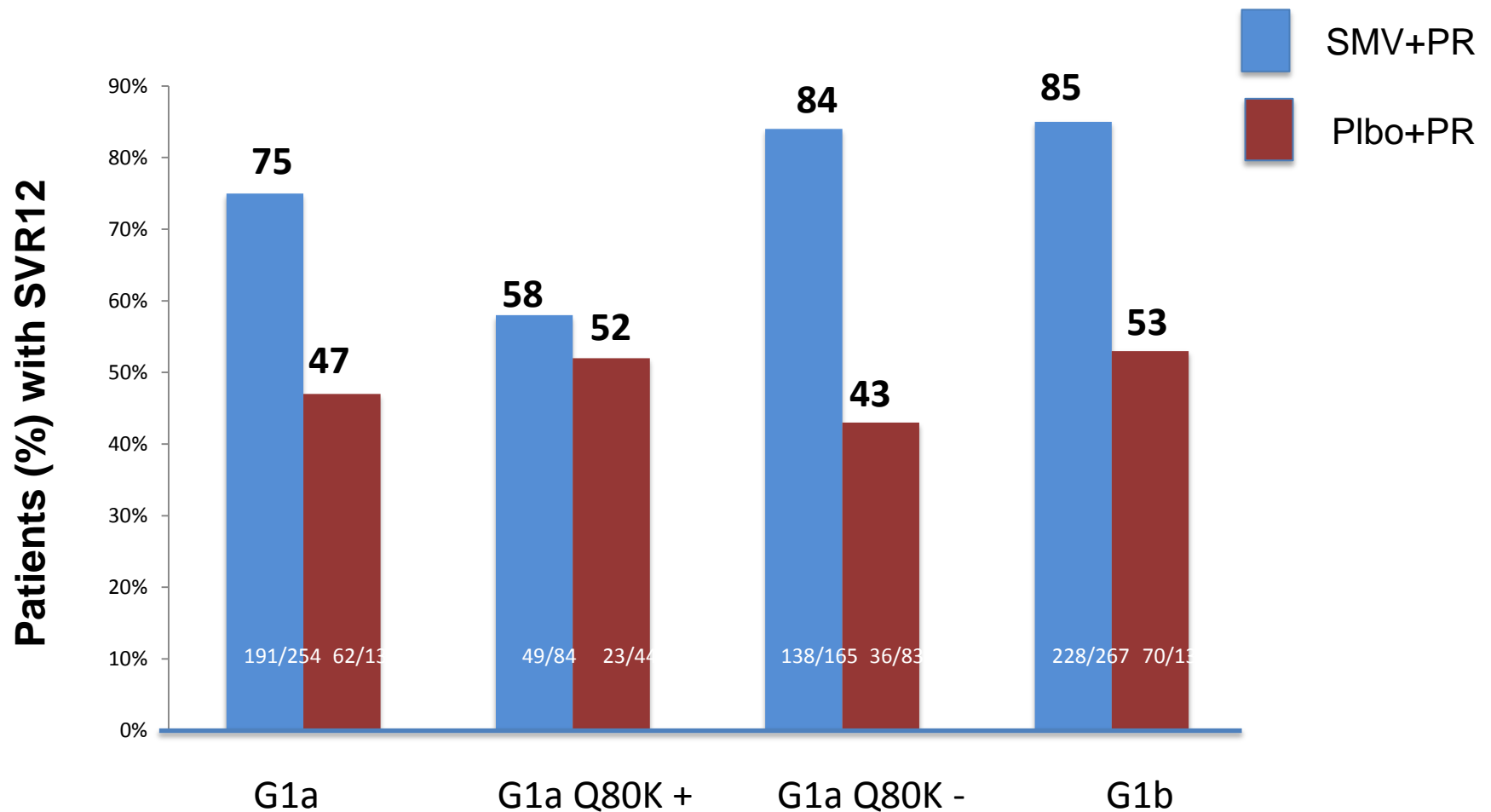

Prévalence de la mutation Q80K en Europe

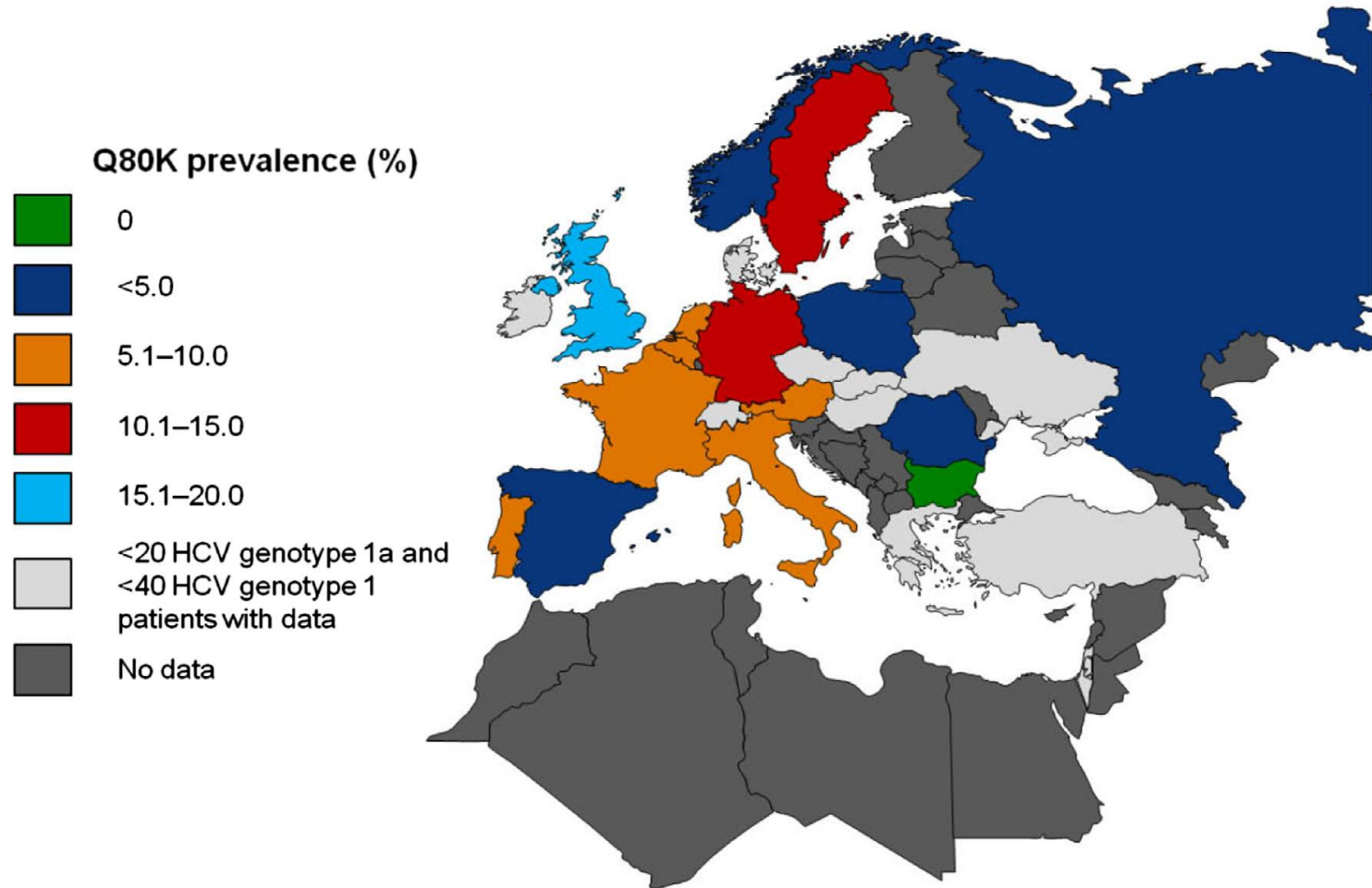

Am.Nord : 48.1 %

Am.Sud : 9.1%

Pooled Quest-1 et 2

Echec et Rechute

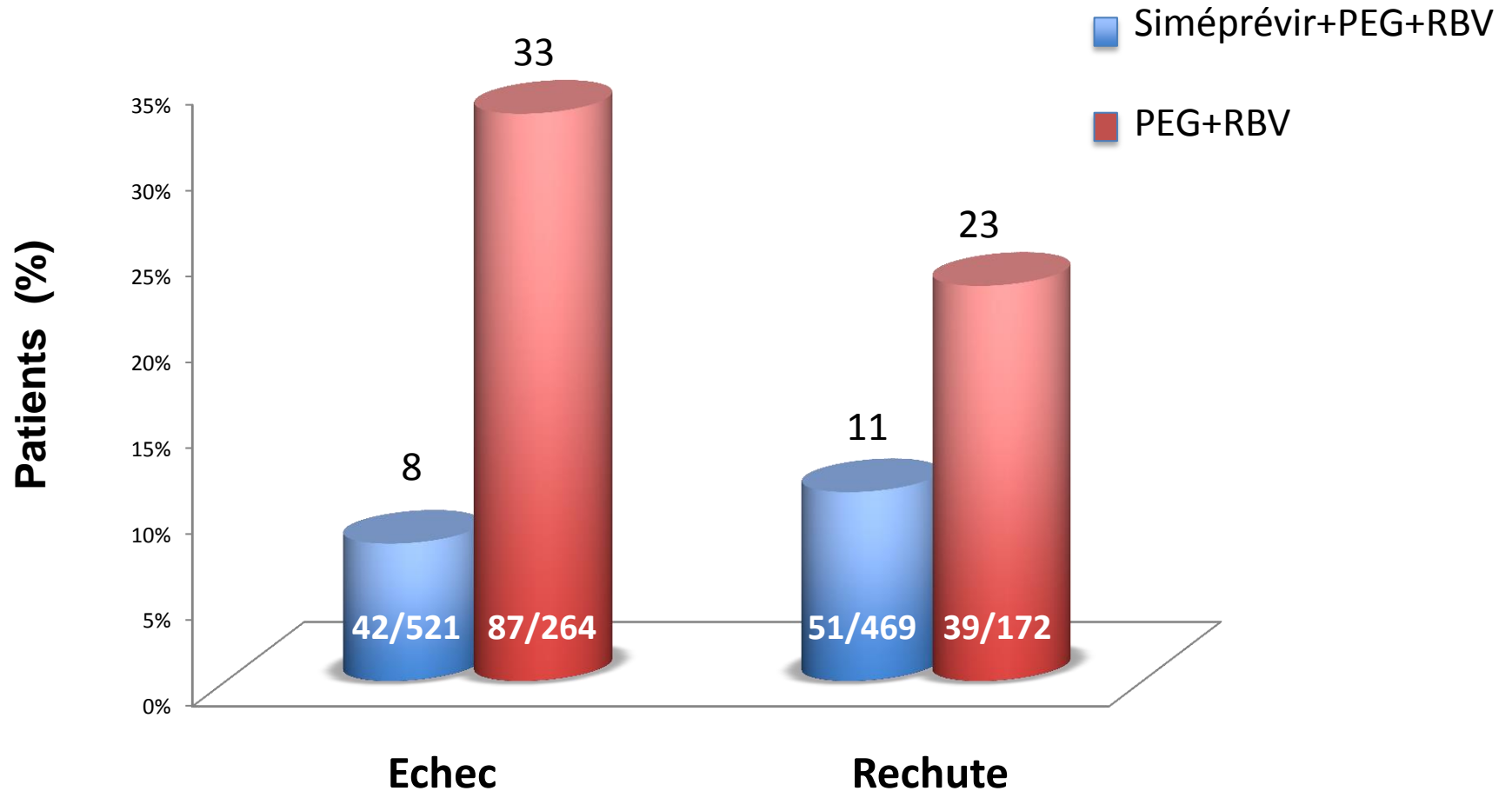

* Echec : ARN détectable en fin de traitement

Profil des mutations en cas d'échec

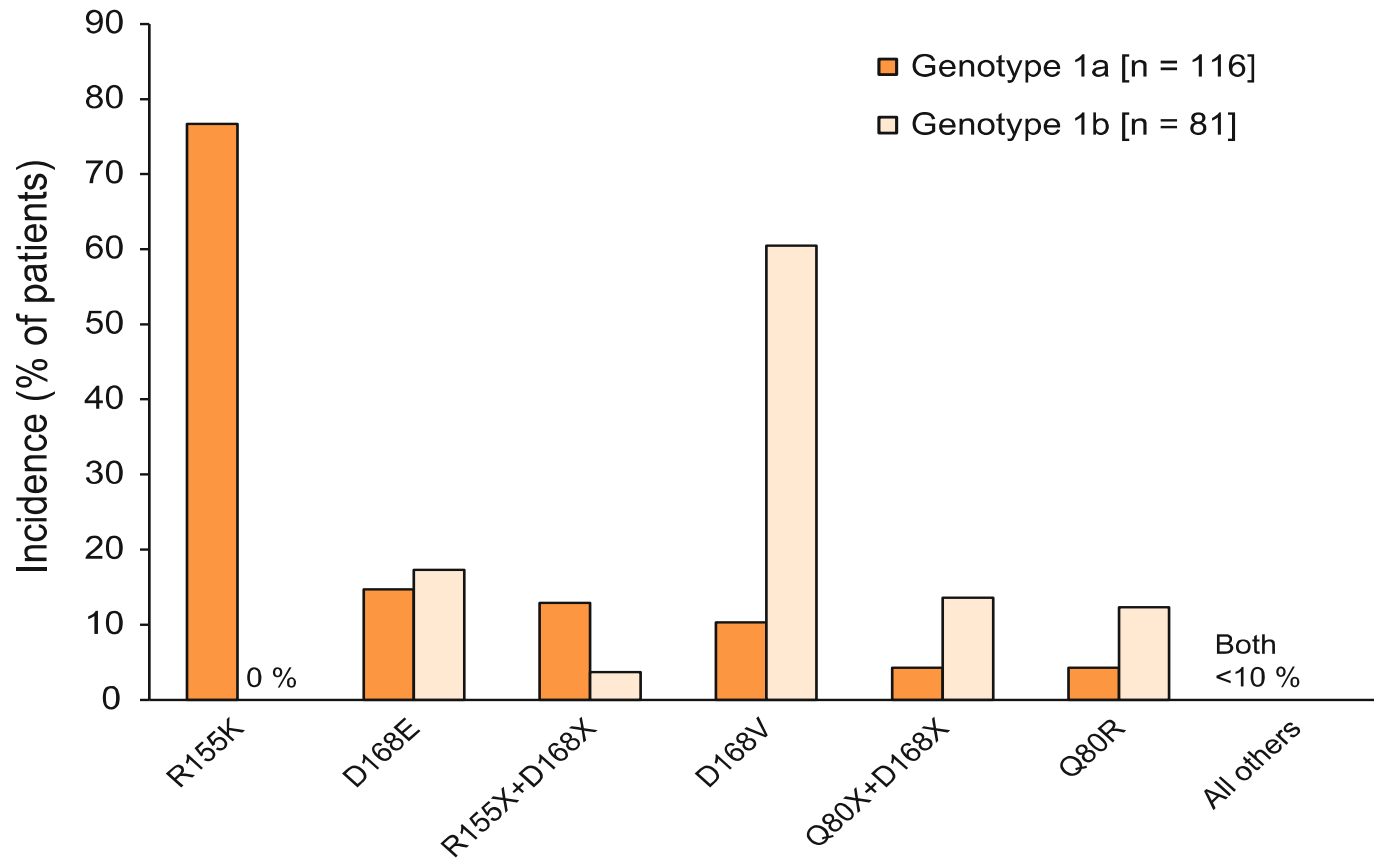

Summary of Safety Data With Simeprevir

- Safety profiles similar between groups through first 12 wks of treatment
 - No increase in anemia with SMV; slightly higher rash or photosensitivity
 - Mild, transient bilirubin increases with SMV; other liver parameters did not change

	QUEST-1 ^[1]		QUEST-2 ^[2]	
	SMV + PR (n = 264)	PR (n = 130)	SMV + PR (n = 257)	PR (n = 134)
Grade 1/2 AEs	72	65	70	73
Grade 3/4 AEs	23	29	26	24
Serious AEs	3	4	2	2
AEs leading to SMV/placebo discontinuation	3	3	2	1
AEs of interest				
▪ Pruritus	21	11	19	15
▪ Rash (any type)	27	25	24	11
▪ Anemia	16	11	14	16
▪ Bilirubin increase	9	4	NR	NR
▪ Photosensitivity conditions	3	1	4	1

Etudes Quest 1 et 2 : Résumé

- SMV 150 mg + PR chez les patients naïfs au traitement, infectés par le VHC de génotype 1 :
 - * 81.3 % de RVS 12
 - * 85 à 91 % des patients étaient éligibles pour une durée totale de 24 semaines
 - Parmi eux , 86 à 91% ont atteint une RVS 12
- Profil de tolérance favorable

Simeprevir in Genotype 1 (Rechuteurs) PROMISE Trial

Forns X, et al. *Gastroenterology*. 2014;146:1669-79

PROMISE Trial: Study Features

- **Design:** Randomized, double-blind, placebo-controlled phase 3 trial of triple therapy with simeprevir, peginterferon alfa-2a, and ribavirin
- **Entry Criteria**
 - Treatment-experienced, chronic HCV mono-infection
 - Viral relapse with prior (≥ 24 weeks) of peginterferon-based therapy
- **Patient Characteristics**
 - **N = 393**
 - HCV Genotype: 1a (42%); 1b (58%)
 - IL28B Genotype: 76% non-CC
 - Age and Sex: median age 52; 66% male
 - Liver disease: F3 : 15 % ; F4 : 15 %
- **Primary end-points:** Efficacy (SVR12)

PROMISE Trial: Design

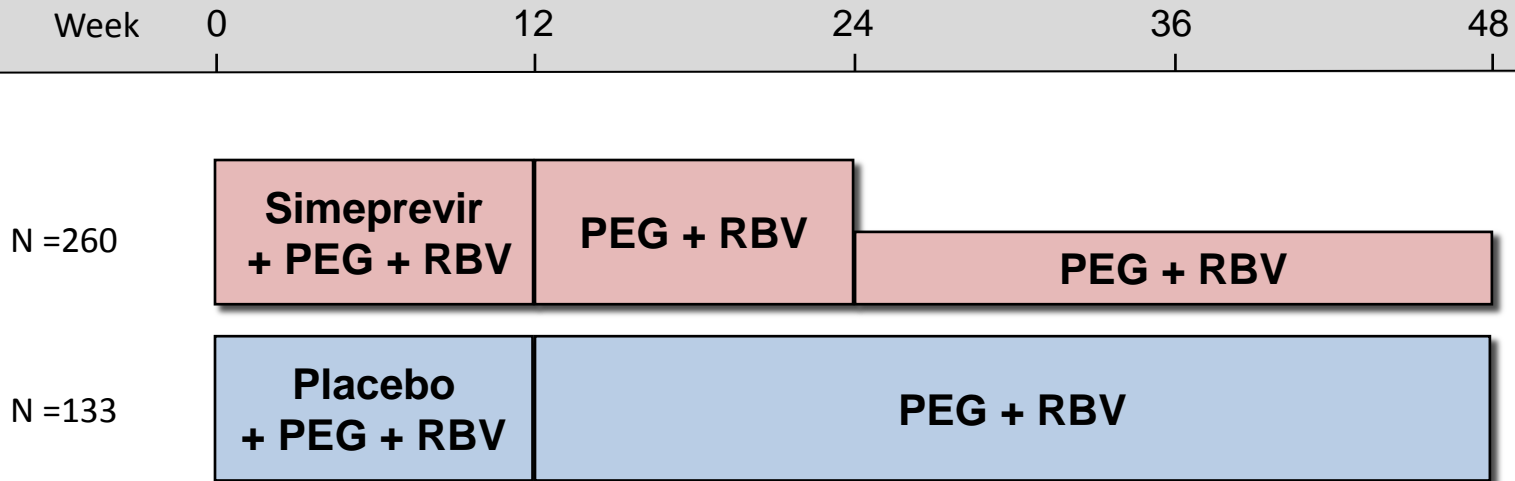

Study Notes

- Randomized 2:1, stratified on IL28B and HCV subtype
- Response-guided therapy (RGT): In simeprevir study arm, patients with HCV RNA <25 IU/ml at week 4 (undetectable or detectable) and <25 IU/ml at week 12 (undetectable) stopped treatment after 24 weeks

Drug Dosing

Simeprevir: 150 mg once daily

Peginterferon alfa-2a (PEG): 180 mcg/week

Ribavirin (RBV) weight-based (in 2 divided doses): 1000 mg if < 75kg or 1200 mg/day if ≥ 75kg

PROMISE Trial: Results

Proportion of Patients with SVR12

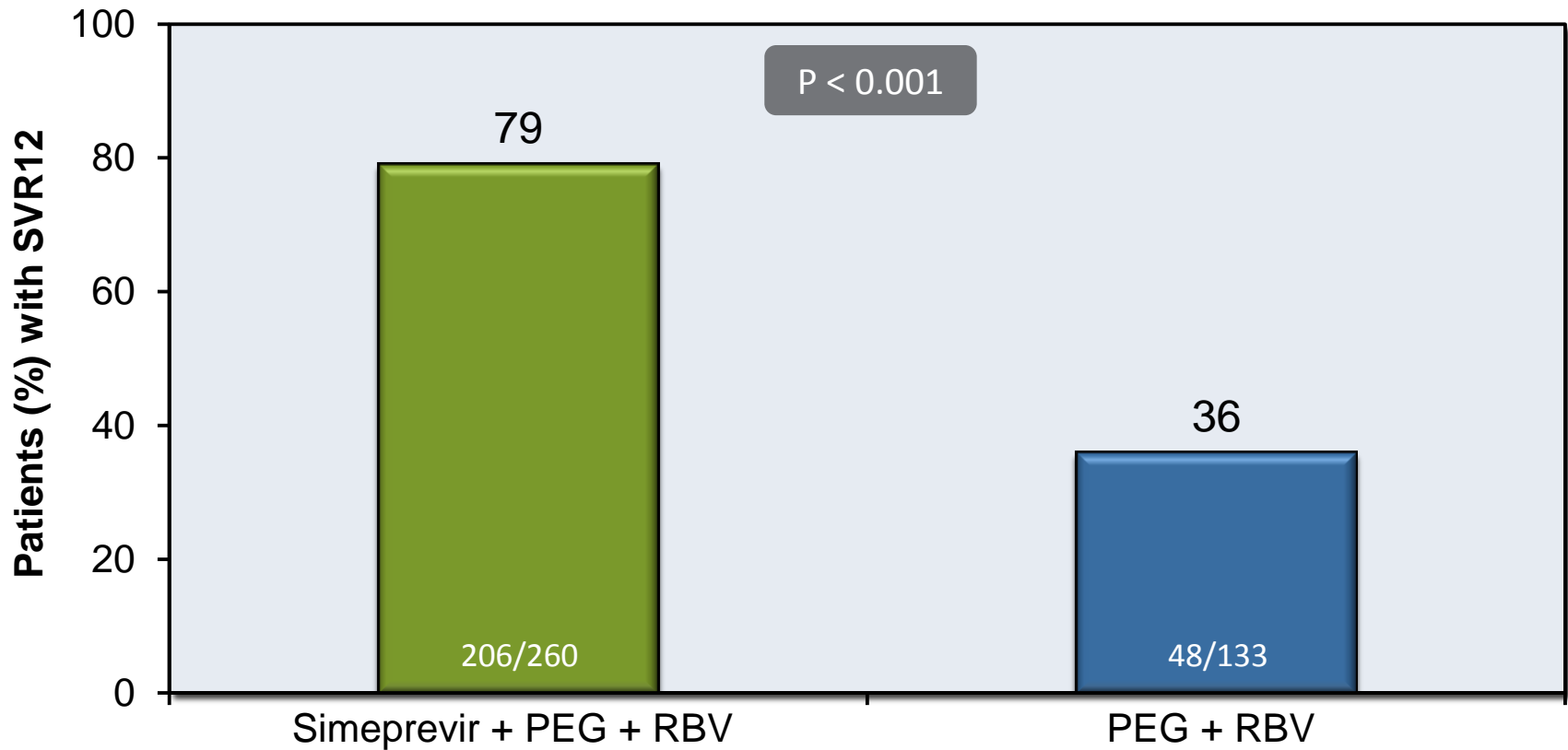

Abbreviations: SVR12 = sustained virologic response at 12 weeks; PEG = peginterferon; RBV = ribavirin

PROMISE Results

SVR12 by HCV Genotype 1 Subtype

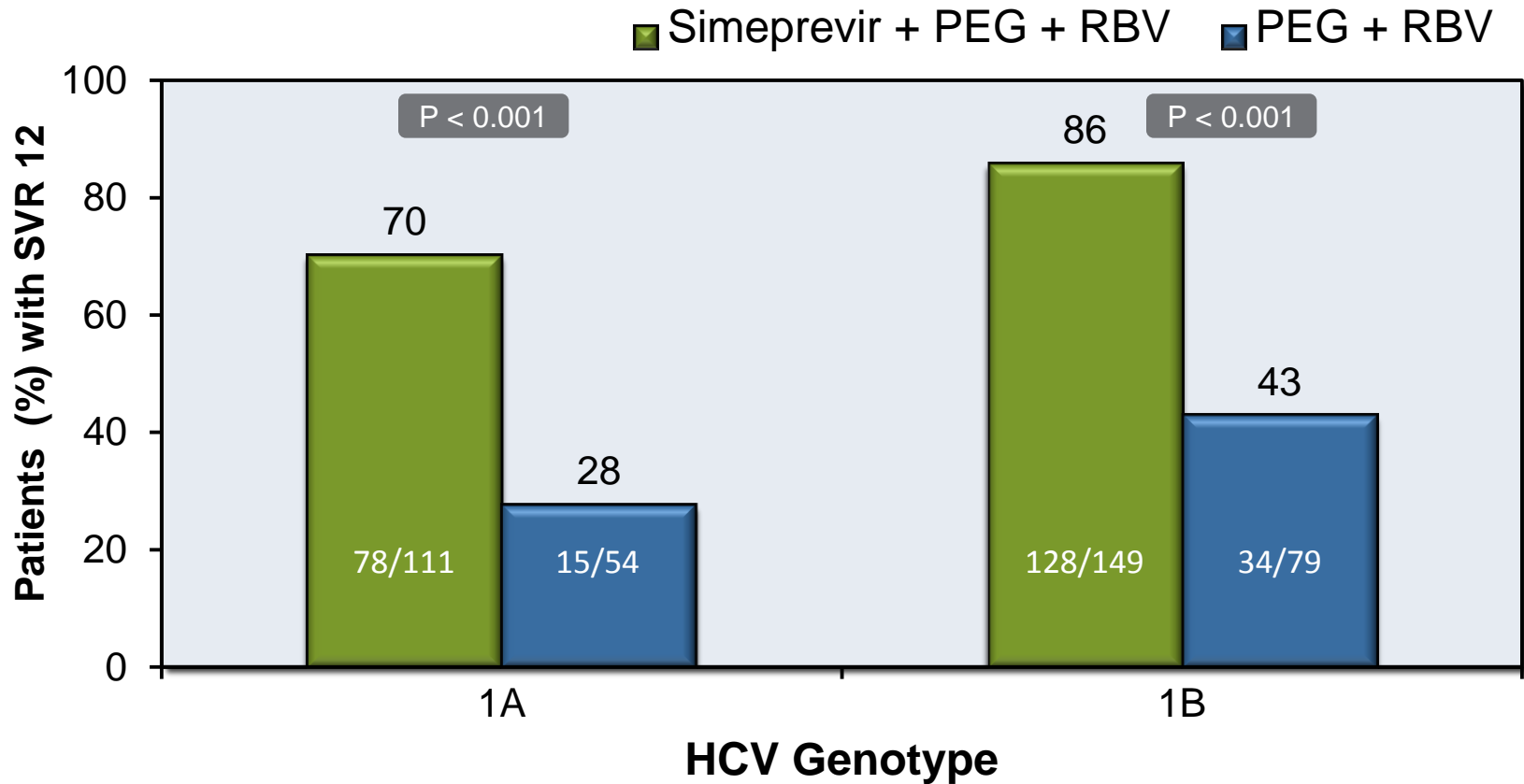

PROMISE Results

SVR12 Response in Simeprevir Arm Based on RGT Criteria

Patients (%) who Met RGT Criteria

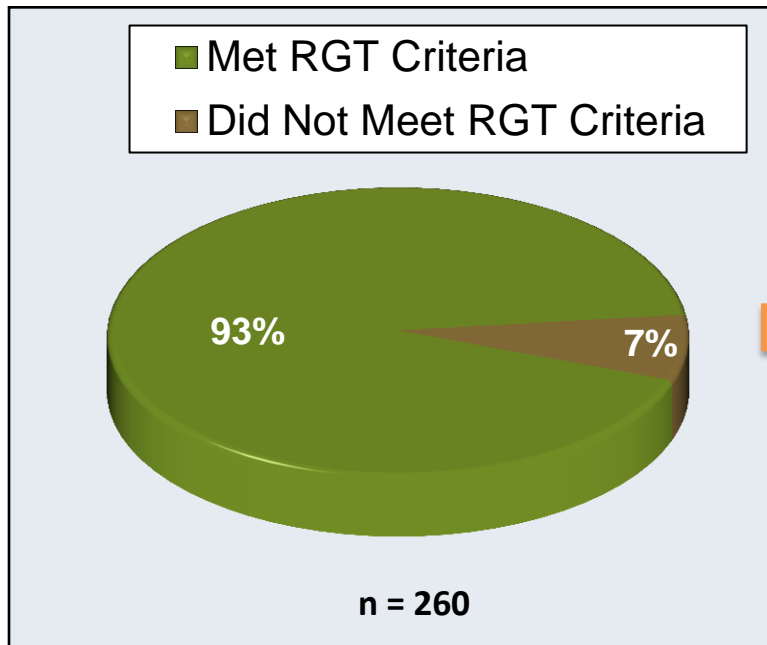

Patient (%) with SVR 12 Response

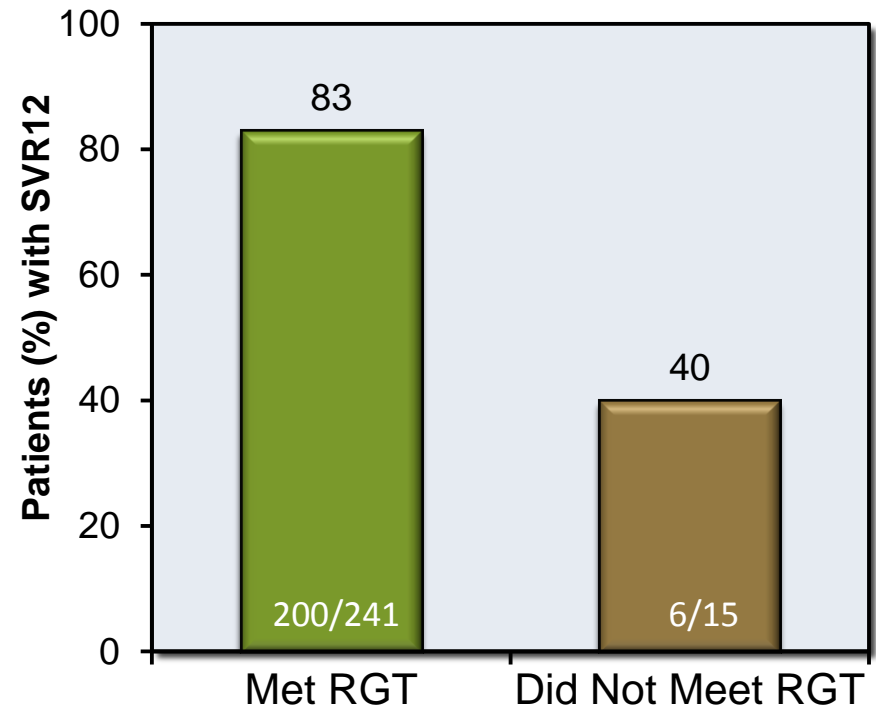

RGT= response-guided therapy: in simeprevir study arm, patients with HCV RNA <25 IU/ml at week 4 (undetectable or detectable) and <25 IU/ml at week 12 (undetectable) stopped treatment after 24 weeks

PROMISE Trial: Results

SVR12 by Host *IL28B* Genotype

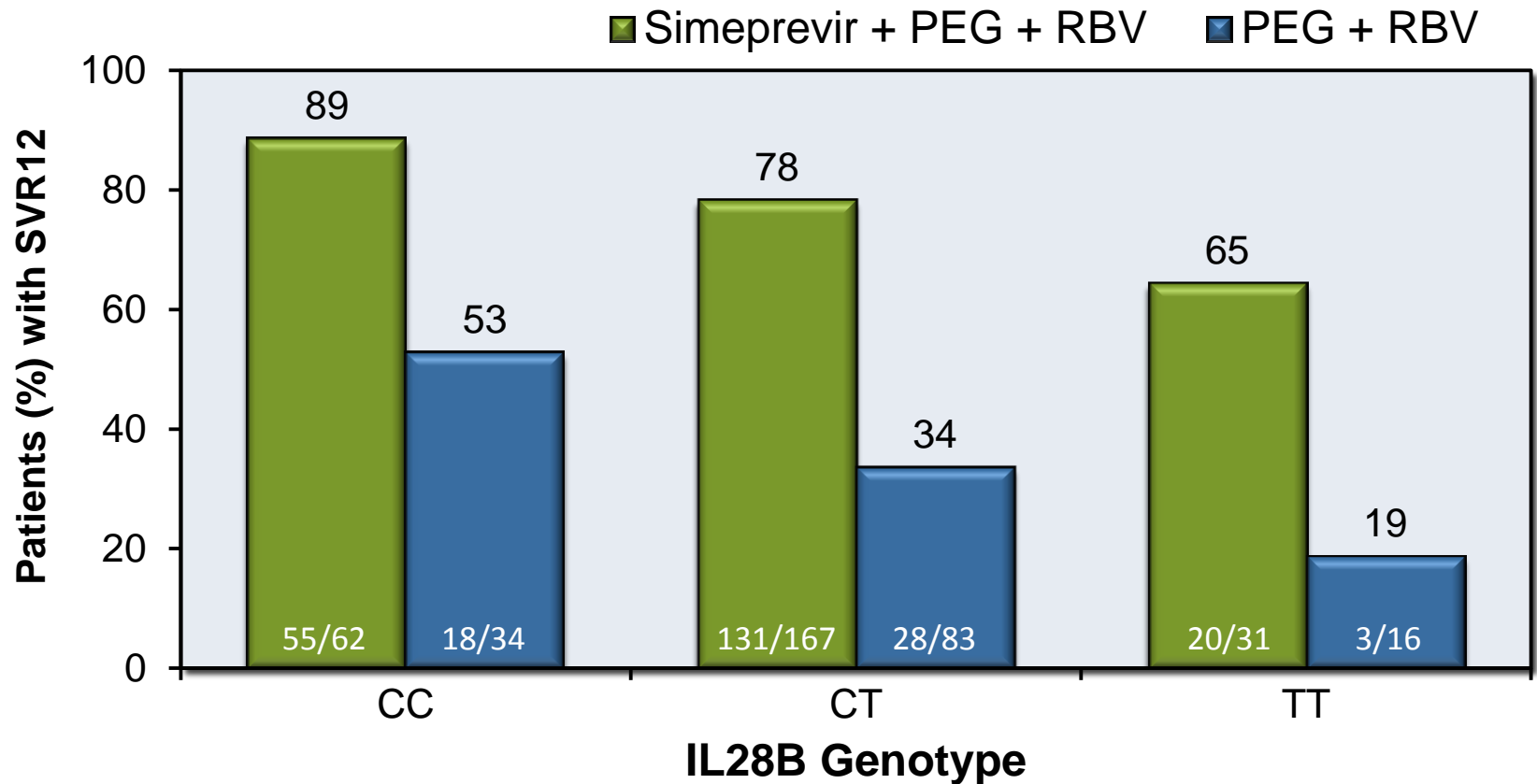

Abbreviations: SVR12 = sustained virologic response at 12 weeks; PEG = peginterferon; RBV = ribavirin

PROMISE Trial: Results

SVR12 by Liver Fibrosis (METAVIR Fibrosis Score)

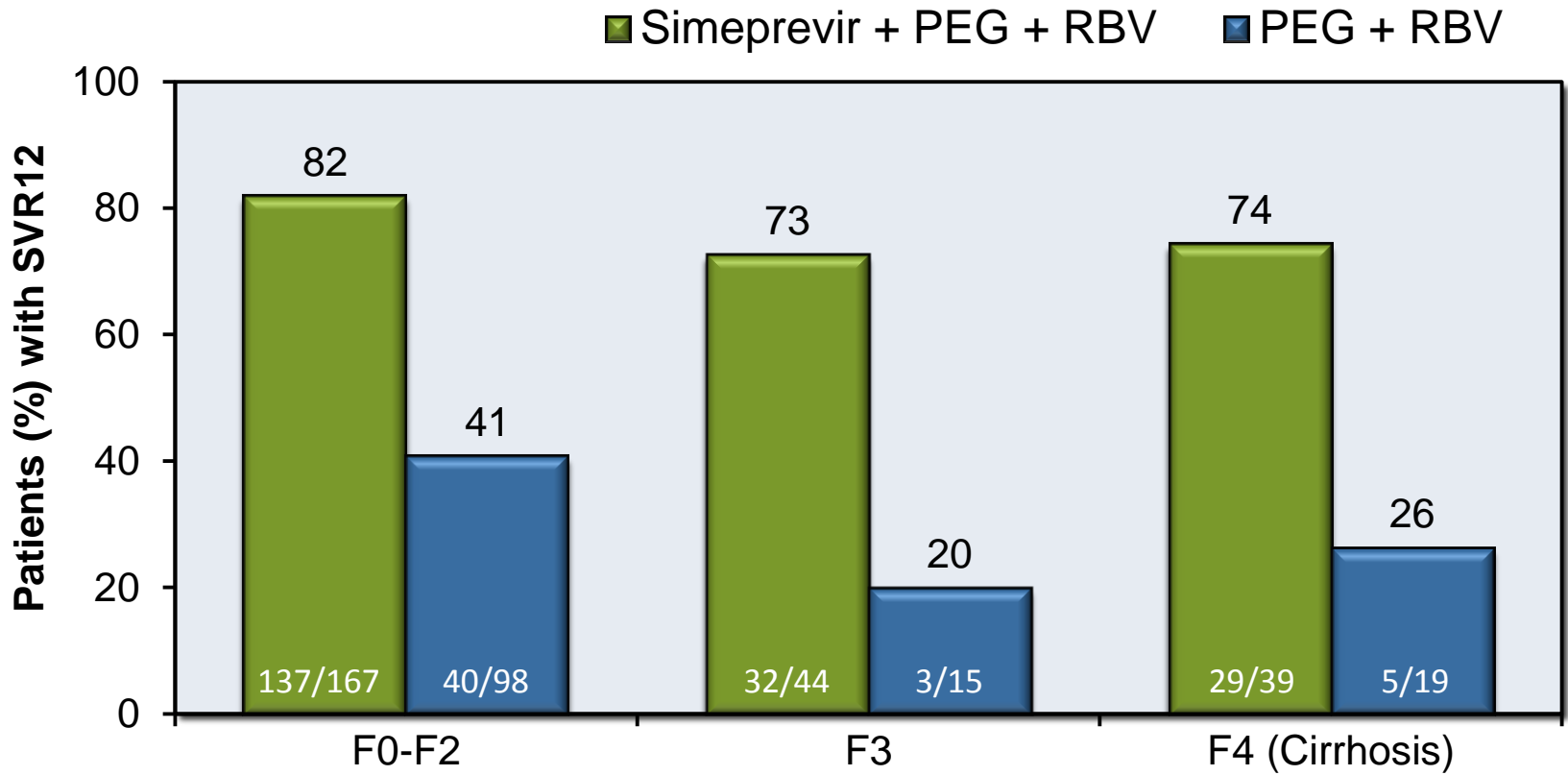

Abbreviations: SVR12 = sustained virologic response at 12 weeks; PEG = peginterferon; RBV = ribavirin

PROMISE Results

Patients Who Had On-Treatment Failure or Relapse

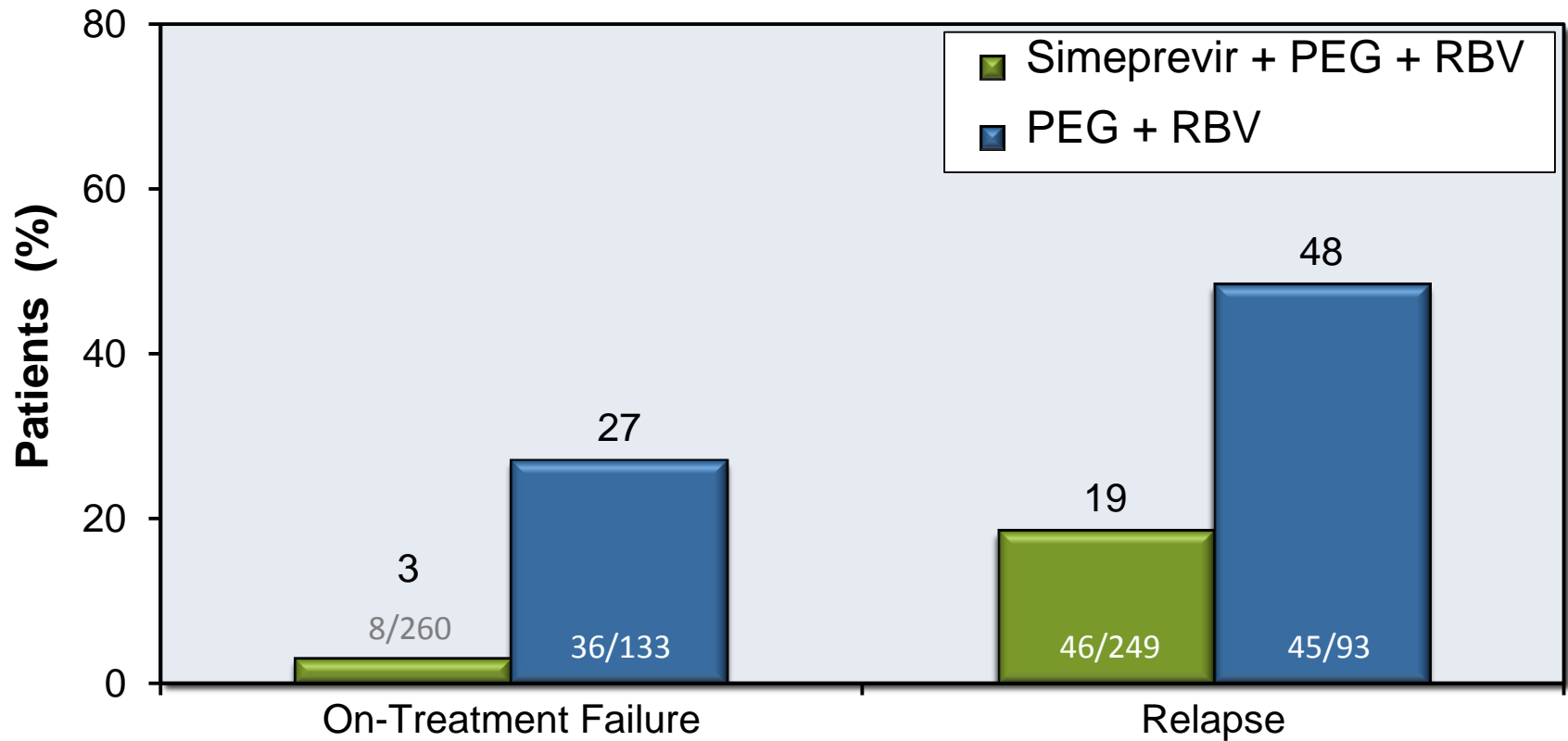

Abbreviations: PEG = Peginterferon; RBV = Ribavirin
On-Treatment Failure: Detectable HCV RNA at end of treatment.

Treatment Naïve and Treatment Experienced

Simeprevir with Peginterferon and Ribavirin in GT-4 RESTORE

Moreno C, et al. J Hepatol 2015

RESTORE Trial: Features

- **Design:** Open-label, phase 3, study evaluating simeprevir + PEG + RBV for treatment naïve and experienced patients with genotype 4 chronic HCV
- **Setting:** Multicenter and International
- **Entry Criteria**
 - Chronic HCV genotype 4 (n = 107)
 - Treatment naïve (n = 35) or treatment experienced relapsers (n = 22)
 - Experienced (Non responder): partial (n = 10), null (n = 40)
- **Patient Characteristics**
 - Sex: male 79%
 - Race: white (72%); black (28%)
 - Median age: 49
 - IL genotype: 7.5% CC
 - METAVIR Fibrosis Stage: F4 = 29%; F3 = 14%
- **Primary End-Points:** Efficacy (SVR12)

Simeprevir + Peginterferon + Ribavirin in Genotype 4 RESTORE: Study Design

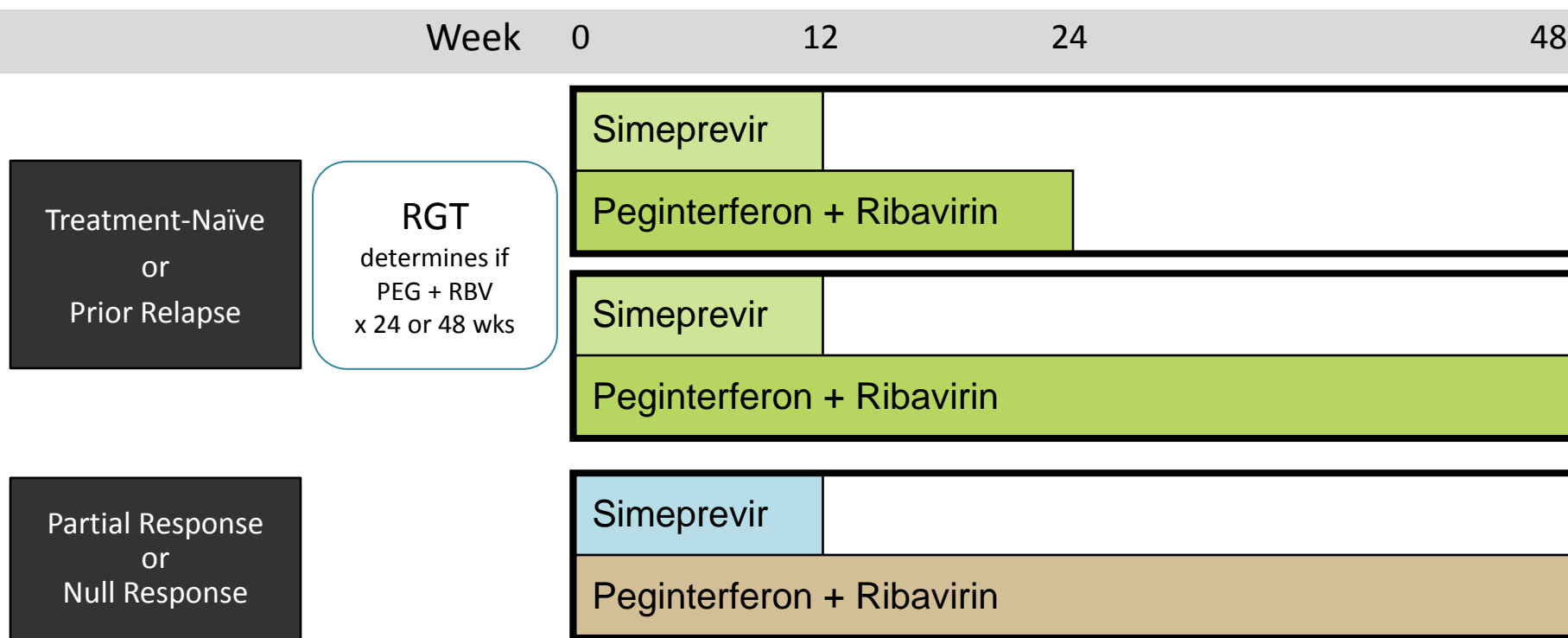

Response Guided Therapy (RGT) Criteria: Week 4 HCV RNA < 25 IU/mL (detectable or undetectable) and Week 12 HCV RNA < 25 IU/mL (undetectable)

Results

RESTORE: SVR12 by Prior Treatment Status

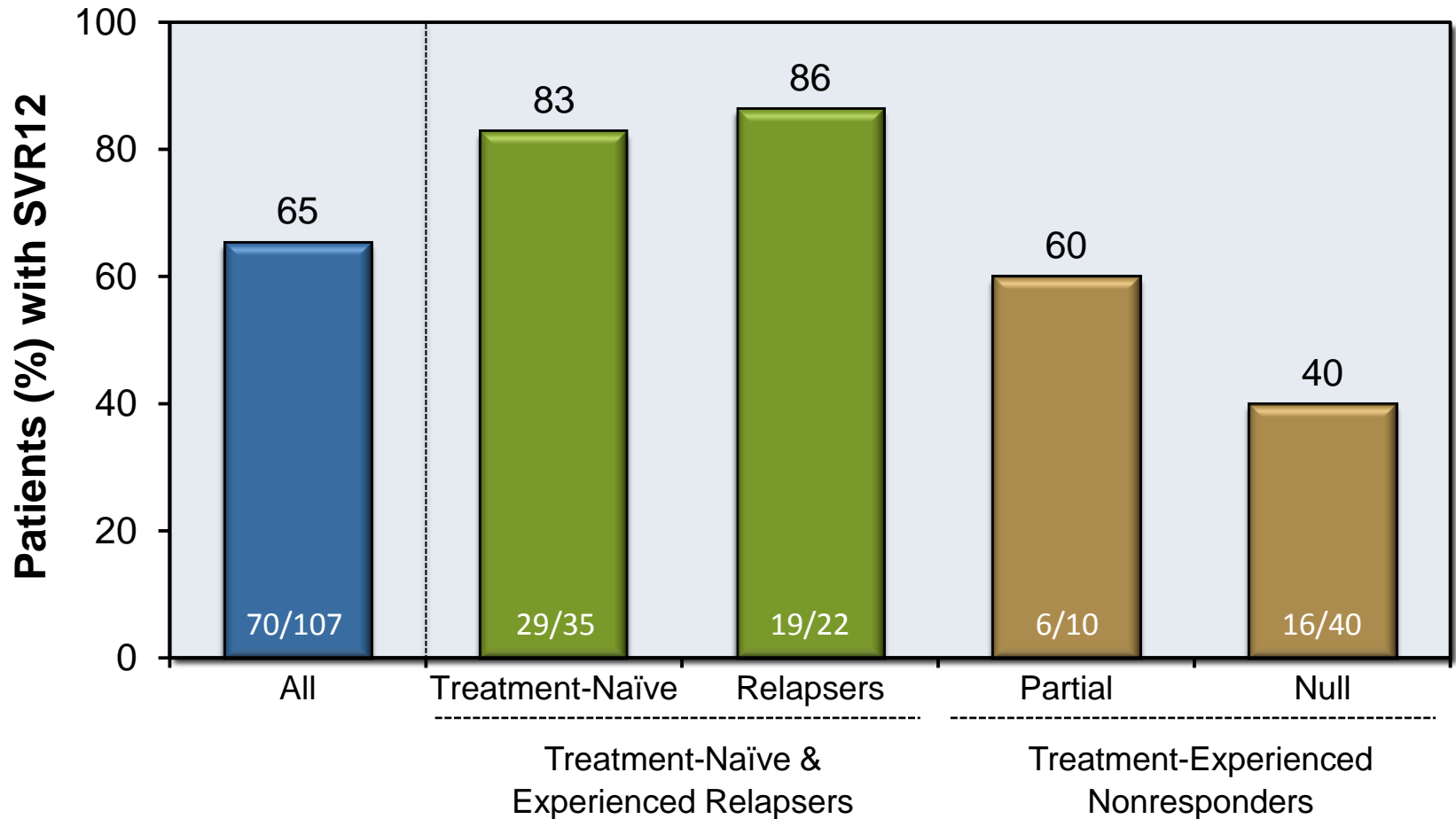

Treatment Naïve and Treatment Experienced

Simeprevir + Sofosbuvir +/- Ribavirin in Genotype 1 COSMOS Trial

Lawitz E, et al. Lancet. 2014

COSMOS Trial: Features

- **Design:** Randomized, phase 2a, open-label, using sofosbuvir + simeprevir +/- ribavirin in treatment naive or experienced, chronic HCV GT 1
- **Setting:** 23 centers in United States
- **Entry Criteria**
 - Chronic HCV Genotype 1
 - Age ≥ 18
 - HCV RNA greater than 10,000 IU/mL
 - Cohort 1: prior **non responders**; Metavir F0-F2
 - Cohort 2: treatment **naïve** & prior **non responders**; Metavir F3-F4
- **Patient Characteristics (range in different treatment arms)**
 - **N = 167** (n = 80 in Cohort 1 and n = 87 in Cohort 2)
 - Baseline GT1a with Q80K: Cohort 1 = 50%; Cohort 2 = 40%
 - Non-CC IL28b Genotype: Cohort 1 = 94%; Cohort 2 = 79%
- **End-Points:** Primary = SVR12; Secondary = safety

COSMOS Trial: Baseline Characteristics

Baseline Characteristic (n = 167)	Cohorts 1 and 2	
Median Age, years (range)	57 (27-70)	
Male, %	64	
White, %	81	
Median Body Mass Index (BMI)	28	
HCV genotype	1a= 78%	1b = 22%
IL28B non-CC genotype, (%)	86%	
Mean baseline HCV RNA, log ₁₀ IU/ml	6.6	
Metavir Score	F1= 20%; F2=28%	F3 = 28%; F4=25%
Previous HCV treatment		
No response (%)	76%	
Treatment-naïve (%)	24%	

COSMOS Trial : Design for Cohort 1

Cohort 1: Prior Non responders ; Metavir Scores F0-F2

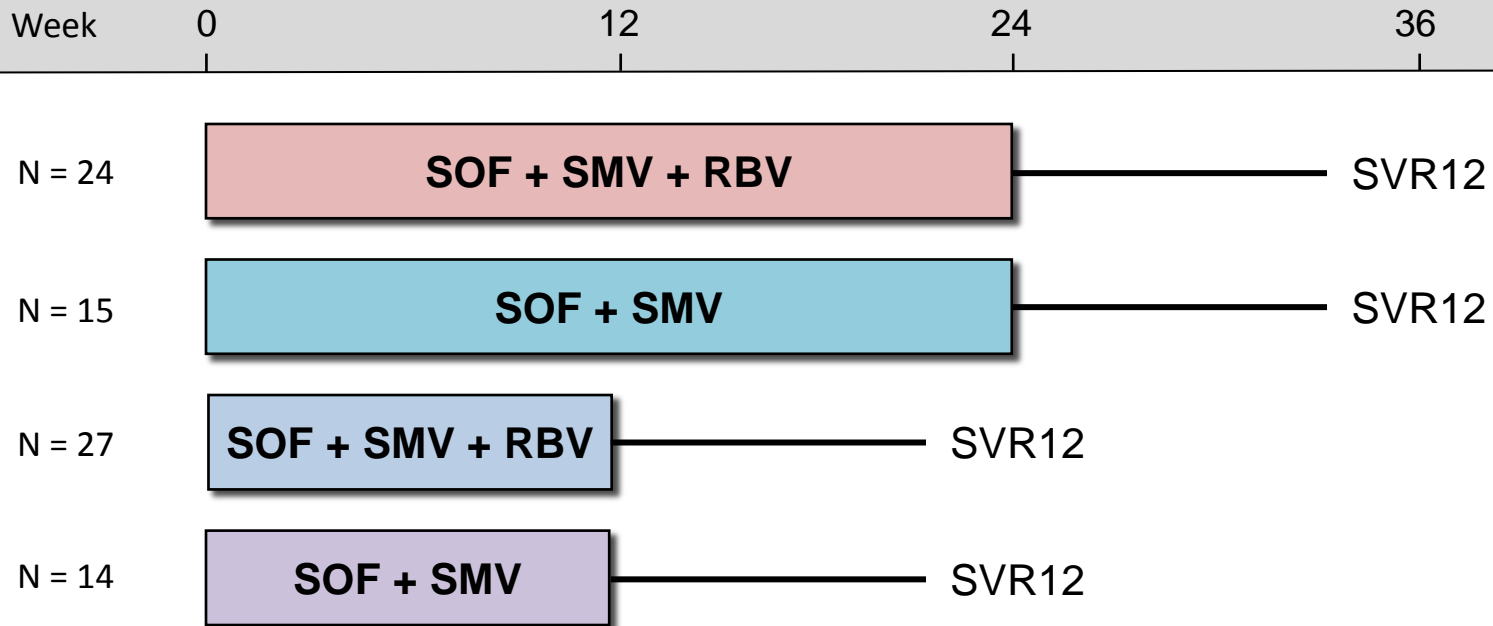

Drug Dosing

SOF= Sofosbuvir: 400 mg once daily

SMP =Simeprevir: 150 mg once daily

RBV = Ribavirin (weight-based and divided bid): 1000 mg/day if < 75 kg or 1200 mg/day if ≥ 75 kg

COSMOS Trial : Results for Cohort 1

SVR 12 by Regimen

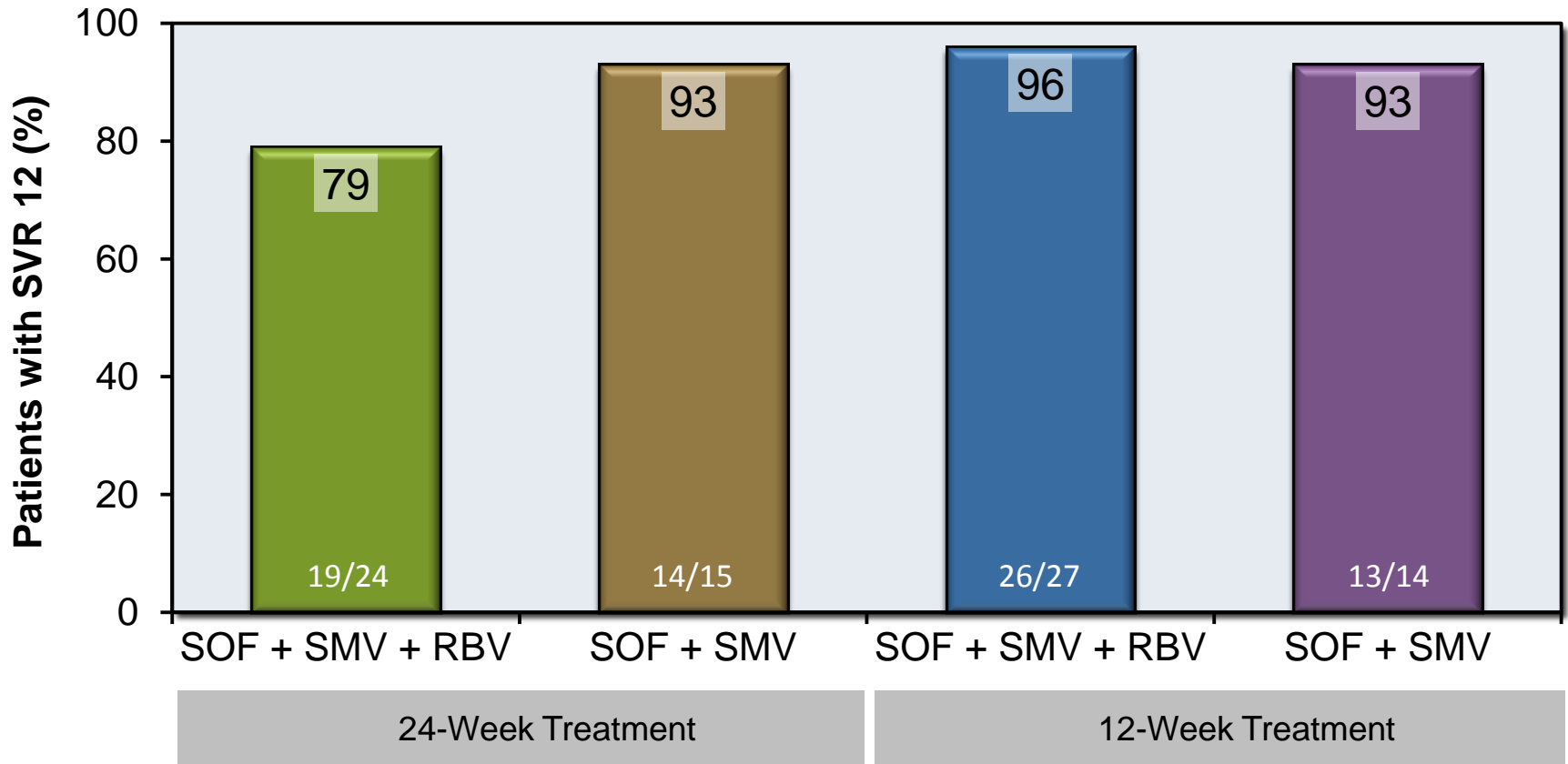

COSMOS Trial: Design for Cohort 2

Treatment Naïve & Prior Non responders ; Metavir Scores F3-F4

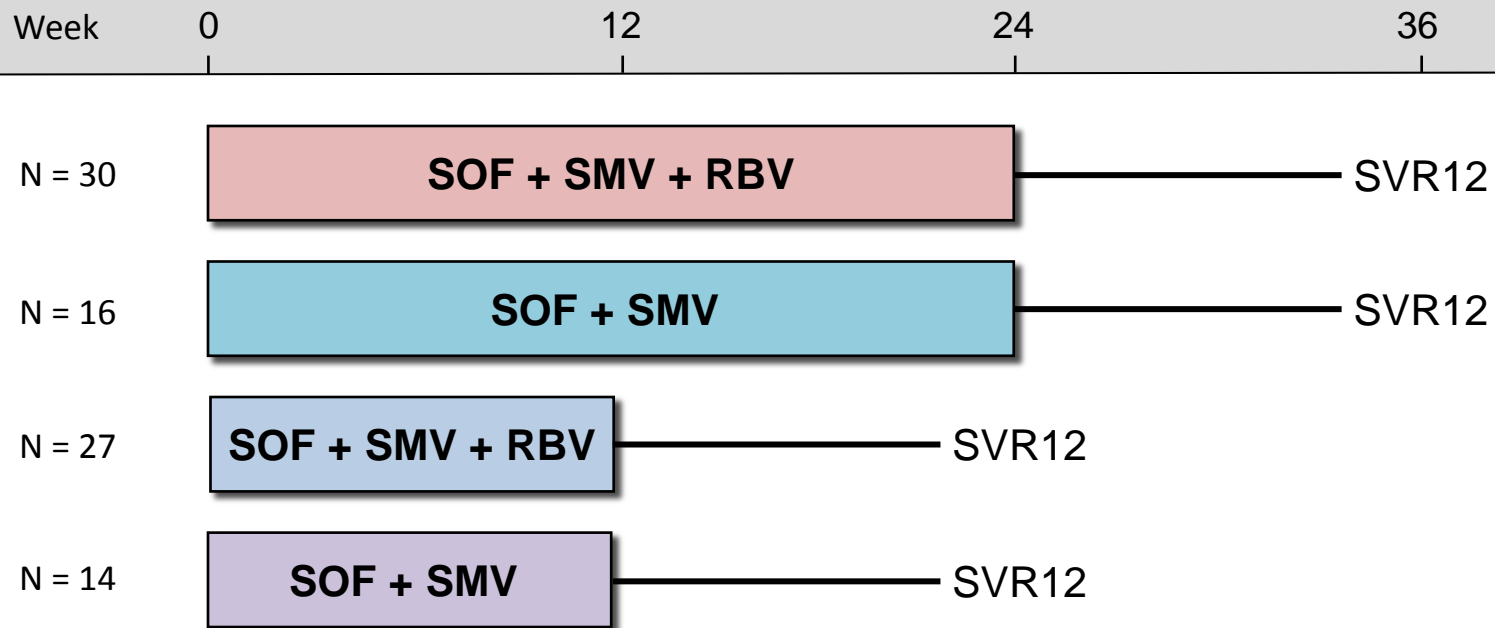

Drug Dosing

Sofosbuvir: 400 mg once daily

Simeprevir: 150 mg once daily

Ribavirin (weight-based and divided bid): 1000 mg/day if < 75 kg or 1200 mg/day if ≥ 75 kg

Siméprévir + Sofosbuvir chez des patients F3 F4

Critère de jugement principal : RVS 12

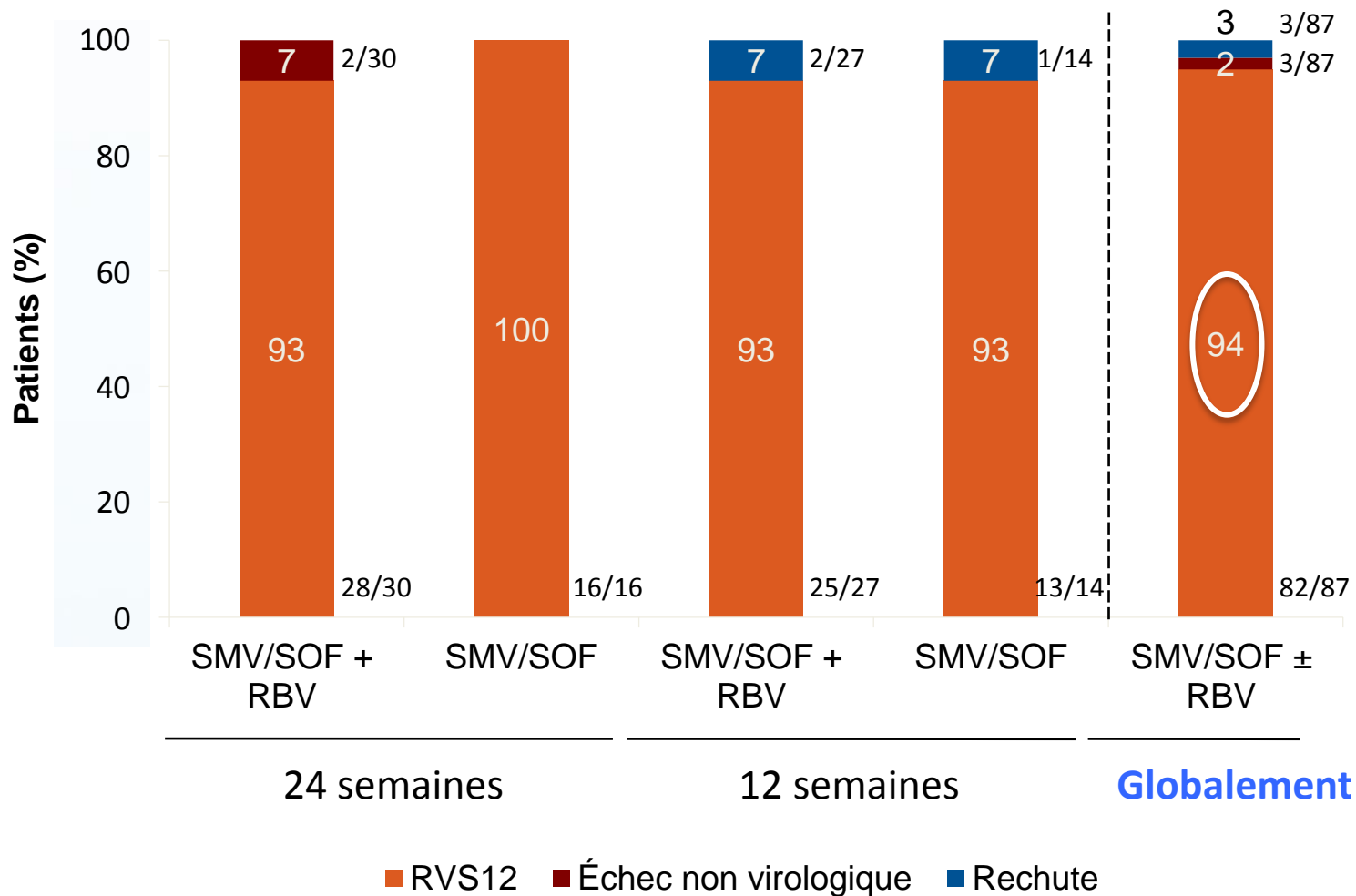

Siméprévir + Sofosbuvir chez des répondeurs nuls

Critère principal de jugement RVS12

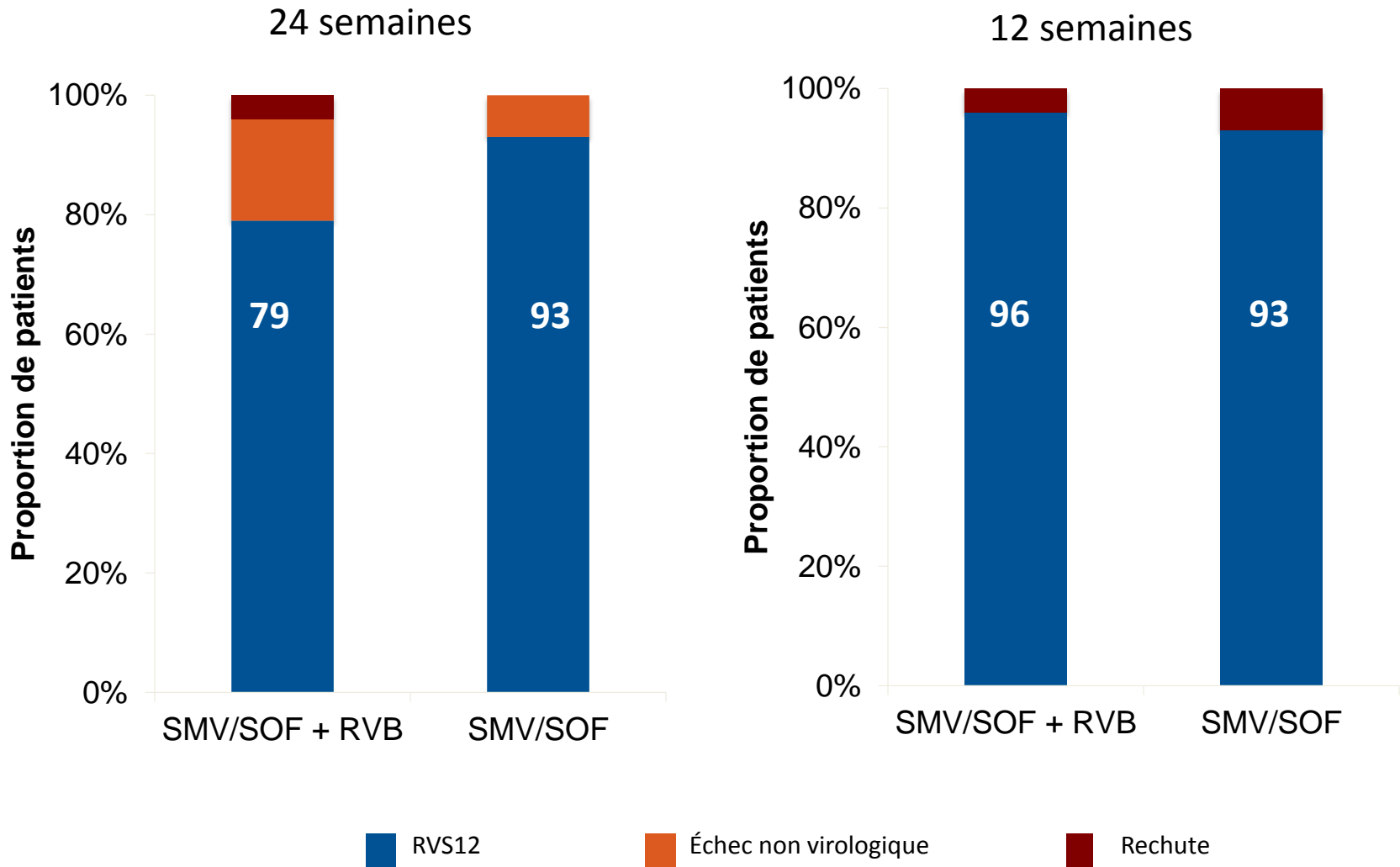

La vraie vie ?

- Résultats des 2 larges cohortes américaines de vraie vie

Cohorte Target

2 330 patients inclus
dans 53 centres américains,
canadiens et allemands

Cohorte Trio

1 211 patients inclus
dans 231 centres
américains

- Protocole de traitement selon les recommandations actuelles

Schémas thérapeutiques

Cohorte (Nb patients traités)	SOF/Peg/RBV	SOF/RBV	SOF/SMV	SOF/SMV/RBV
Target (2 063)	384	667	784	228
Trio (995)	384	227	320	

➔ Recueil des données démographiques, cliniques, virologiques et de tolérance

La vraie vie

- Caractéristiques des patients inclus

	Target (n = 2 063)	Trio (n = 995)
Âge moyen, ans (extrêmes)	57,6 (20-83)	57 (17-86)
Hommes, n (%)	1 300 (63,7)	565 (59)
En échec de traitement, n (%)	1 077 (52,2)	407 (43)
– Échec IP (TVR/BOC) , n (%)	193 (17,9)	82 (20)
Cirrhose, n (%)	999 (48,4)	291 (30)
– ATCD décompensation, n (%)	375 (43,1)	-
Transplantation, n (%)	227 (11)	-
CHC, n (%)	211 (10,2)	-
VIH, n (%)	47 (2,3)	-
Génotypes 1a-1b - 1, n (%)	-	462 (48) – 179 (19) – 62 (6)
Génotype 2, n (%)	-	212 (22)
Génotype 3, n (%)	-	7 (1)

Sofosbuvir/Simeprevir ± ribavirine dans la vraie vie

- **Cohorte Trio - Patients de génotype 1**

- Réponse virologique (per protocole) à **S12** post-traitement avec SOF/SMV ± RBV

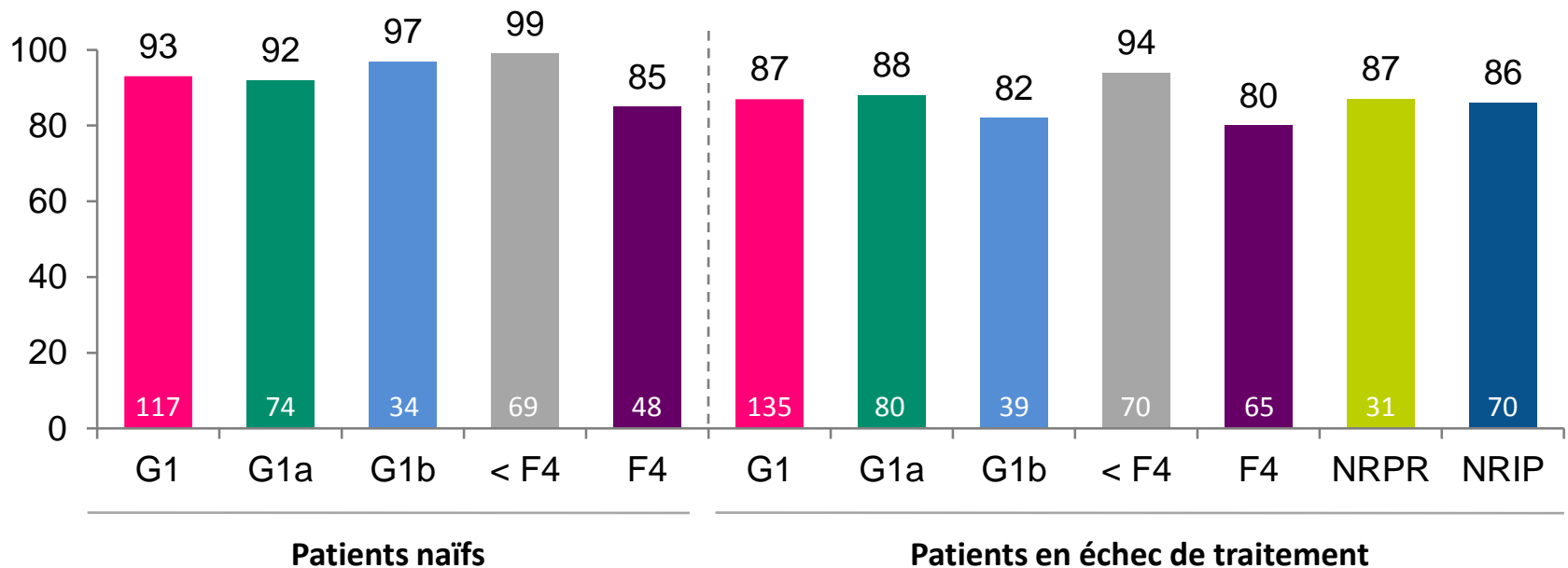

NRPR : non répondeurs aux inhibiteurs de protéase ; NRIP : non répondeurs à Peg + RBV.

- Facteurs d'échec : cirrhose, génotype 1a et antécédents d'échecs aux IP

Sofosbuvir/Simeprevir ± ribavirine dans la vraie vie

- Cohorte Target – Patients de génotype 1

RVS4 en fonction de la présence ou non d'une cirrhose avec ou sans RBV

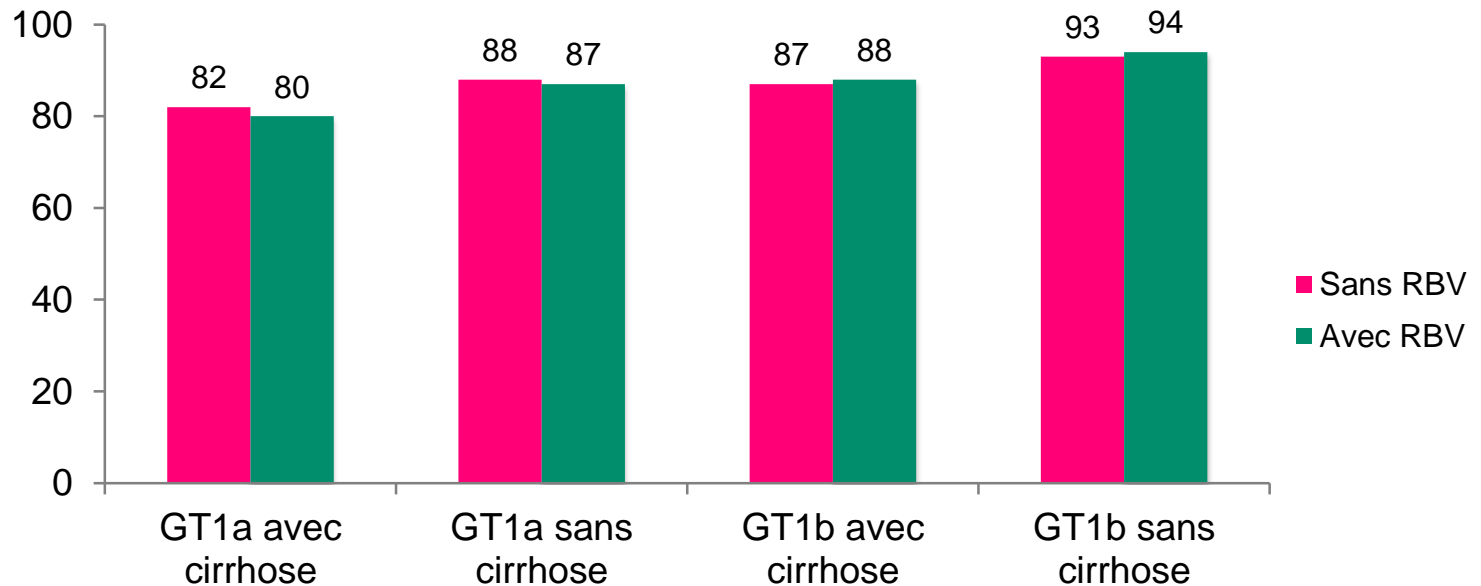

- La RBV n'améliore pas la RVS4
- Ces conclusions seront à confirmer avec les résultats de RVS12 et sur l'effectif total de la cohorte

Étude LEAGUE-1 : simeprevir+daclatasvir ± RBV dans les GT1

Étude de phase II randomisée en ouvert

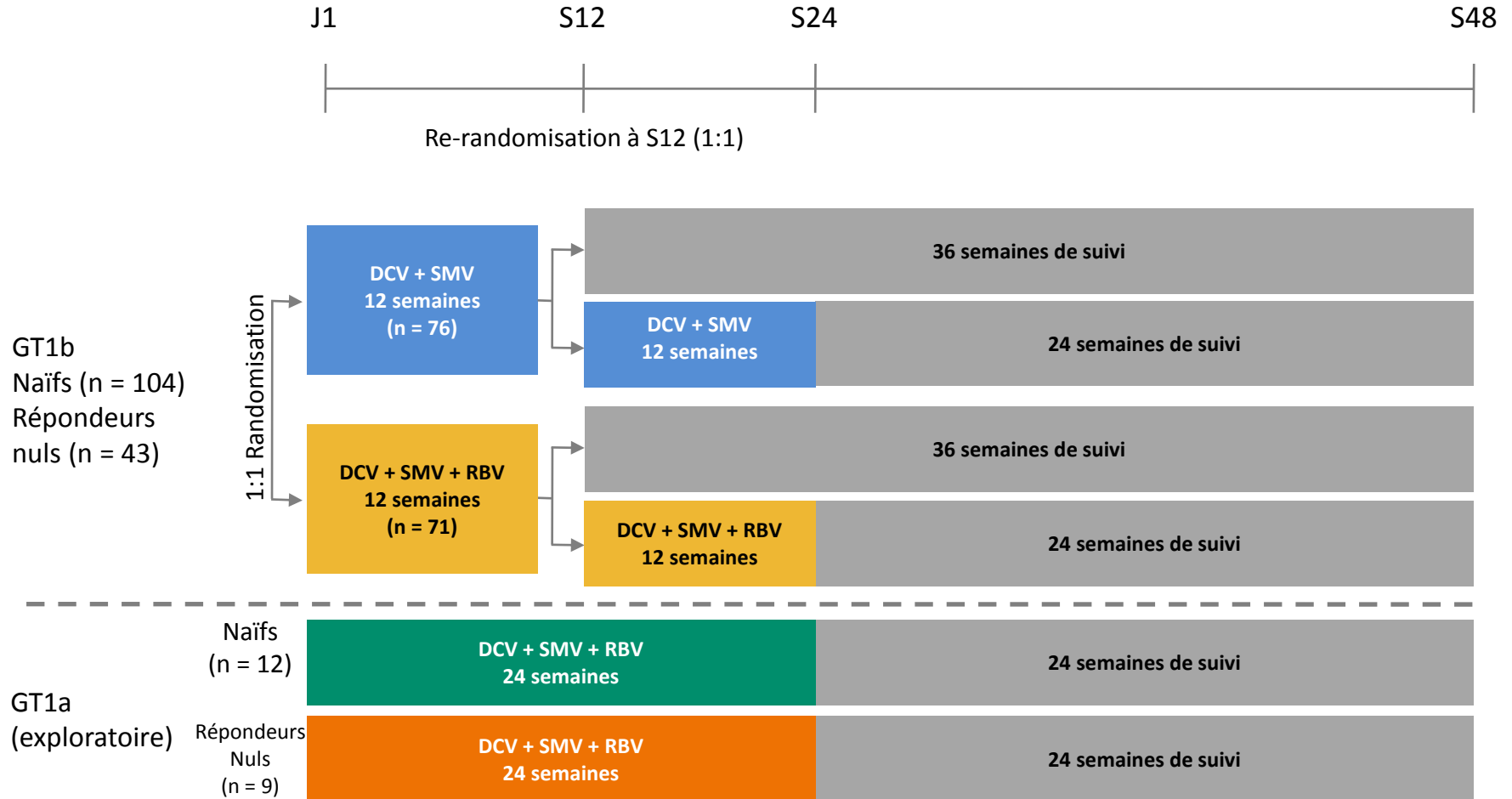

Étude LEAGUE-1 : simeprevir+daclatasvir ± RBV dans les GT1

- Efficacité pour les GT 1b

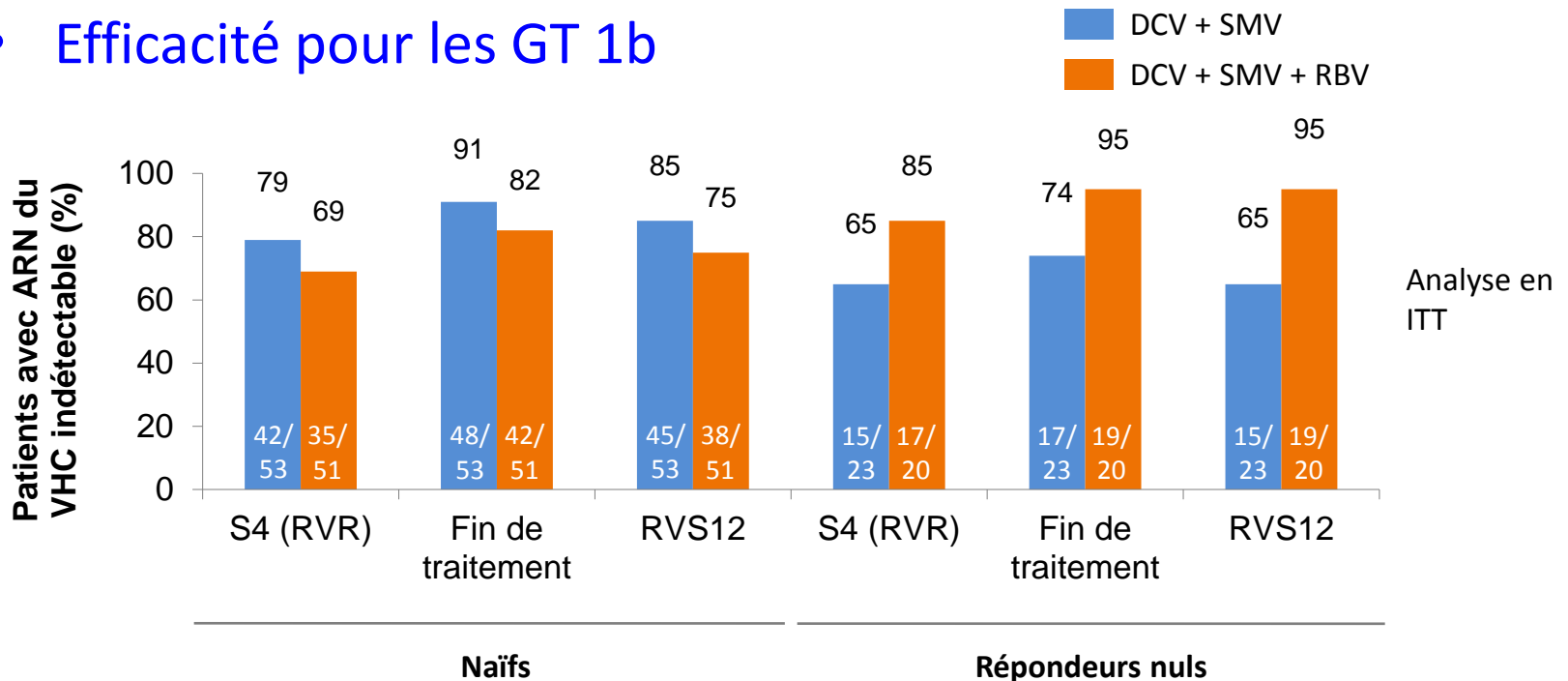

RVS12 "as observed"	n/N (%)	DCV + SMV	DCV + SMV + RBV
Données manquantes en post-traitement à S12 exclues	Naïfs	45/50 (90)	38/46 (83)
	Répondeurs nuls	15/19 (79)	19/20 (95)

Étude LEAGUE-1 : simeprevir+daclatasvir ± RBV dans les GT1

Efficacité pour les GT1a

- Patients naïfs
 - RVS12 chez **67 %** (8/12) des patients
 - Incluant 2/2 patients cirrhotiques et 6/10 non cirrhotiques
 - Échec virologique chez 33 % (4/12) des patients
- Répondeurs nuls
 - Possibilité de bénéficier de l'addition de PR après que 5 patients aient présenté un échec virologique (7 patients au total)
 - 9/9 patients : absence de RVS
- **Cette association DCV 30 mg + SMV 150 mg ± RBV a permis d'obtenir des taux de RVS12 de 75 à 85 % chez les patients naïfs et de 65 à 95 % chez les répondeurs nuls dans les GT 1b**
- **La tolérance a été bonne (hyperbilirubinémies de grade $\frac{3}{4}$ liées à la RBV)**
- **La dose de 60 mg pour le DCV est celle retenue pour les essais futurs – y compris ceux incluant le SMV**

Simeprevir + PEG + Ribavirine et Coinfection VHC/VIH Etude C212

Dieterich D, et al. Clin Infect Dis. 2014 Sep 5

Study Features

- **Design:** Open-label, phase 3, trial evaluating simeprevir + PEG + RBV in HCV-HIV and GT 1 (treatment naïve and experienced)
- **Setting:** 39 sites in 7 countries
- **Entry Criteria**
 - HIV coinfection; HCV genotype 1
 - Treatment naïve or treatment experienced
 - Group 1: HCV treatment-naïve or prior relapse
 - Group 2: Prior partial or null response or cirrhosis
 - CD4 \geq 200 if on stable ARV therapy; CD4 \geq 500 if no ARV therapy
 - Stable antiretroviral therapy = HIV RNA $<$ 50 copies/ml $>$ 8 weeks
- **Patient Characteristics**
 - N = 106 HCV-HIV coinfecting patients
 - Race: white (82%); black (14%)
 - Baseline Median CD4 (cells/mm³): 629 cells/mm³
- **Primary End-Points:** Efficacy (SVR12), safety, and impact on HIV

Design

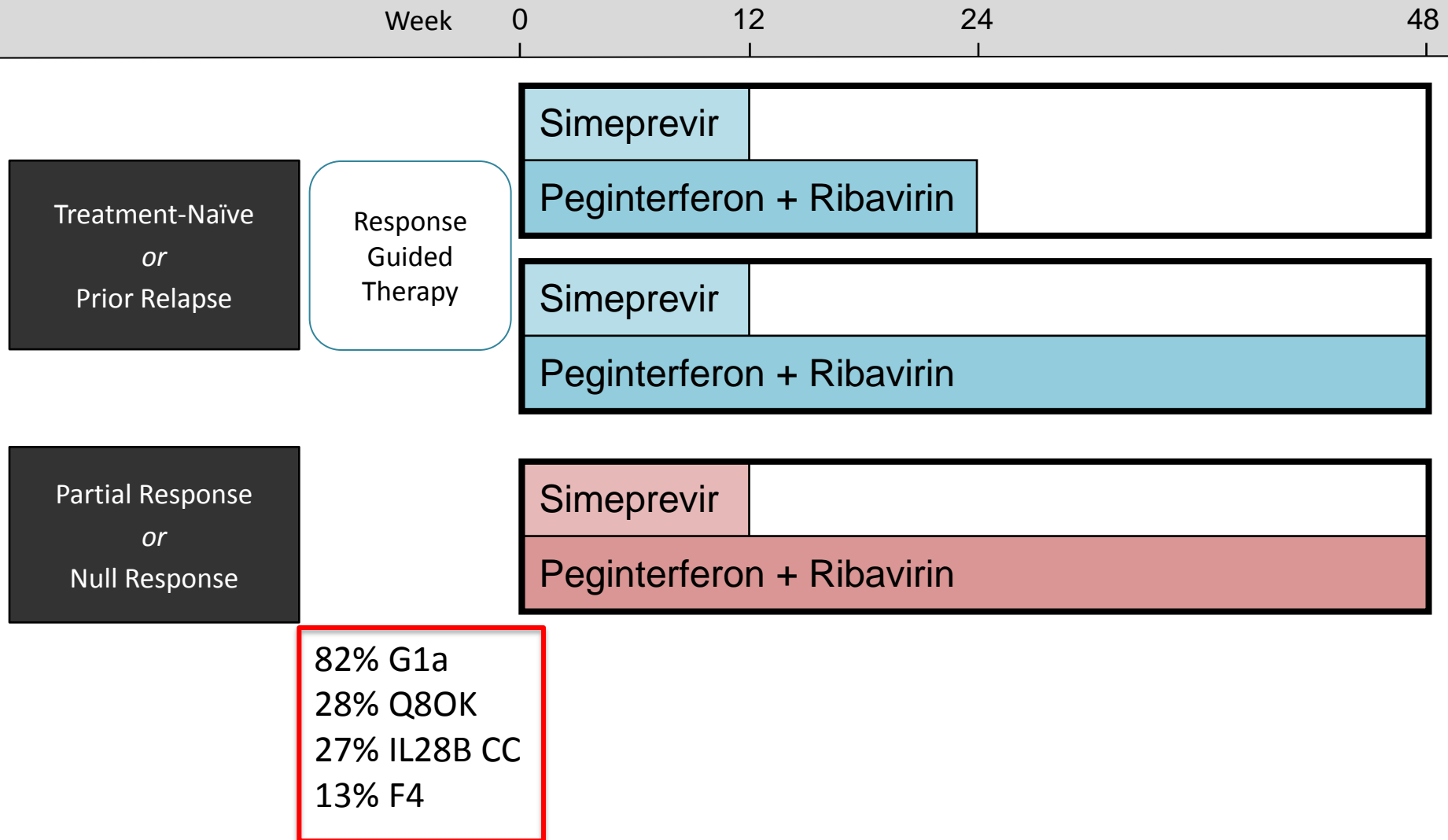

Results

SVR12 by Prior Treatment Status

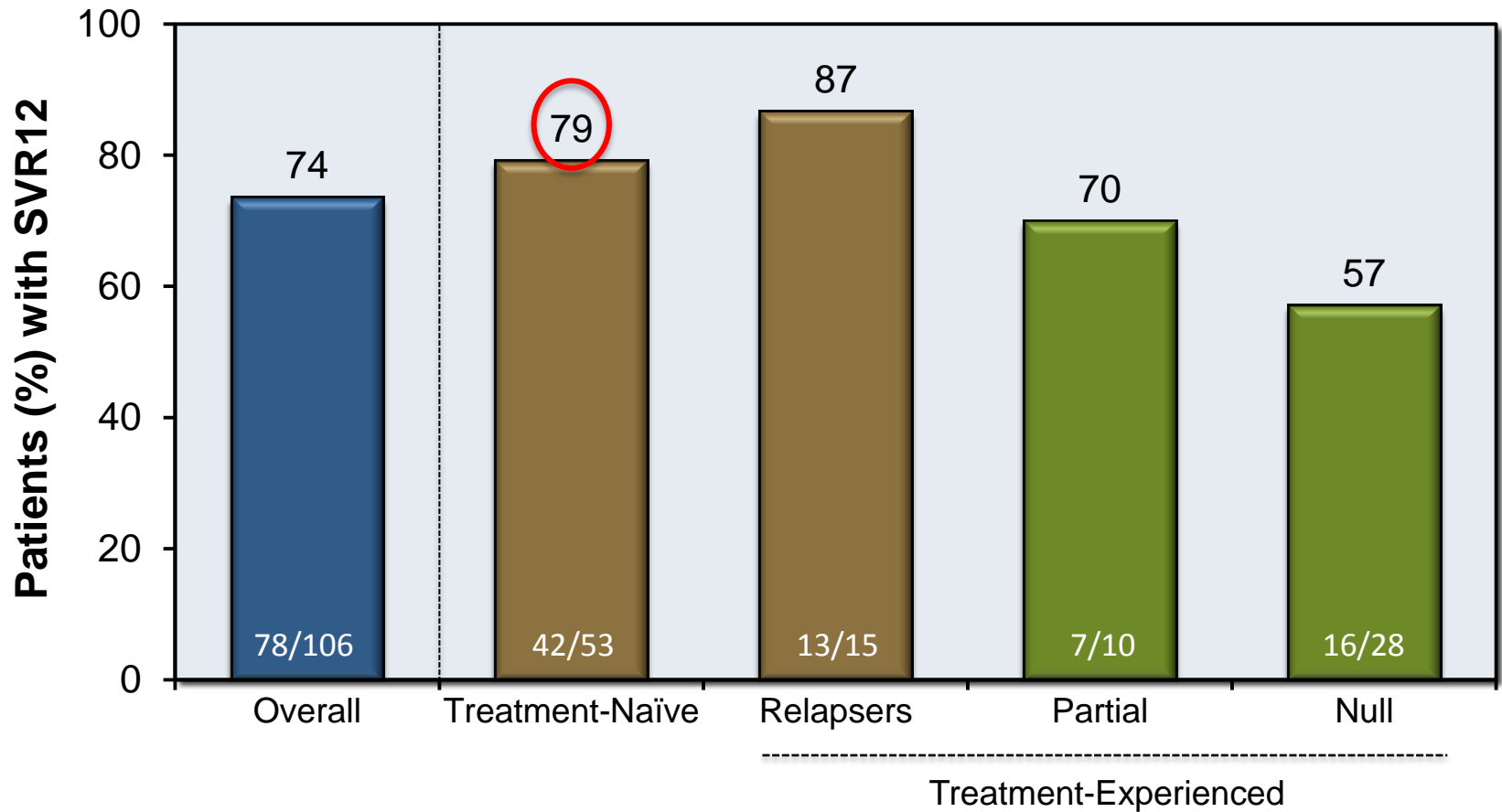

Results

SVR12 by GT1 Subtype and Baseline NS3 Q80K Polymorphism

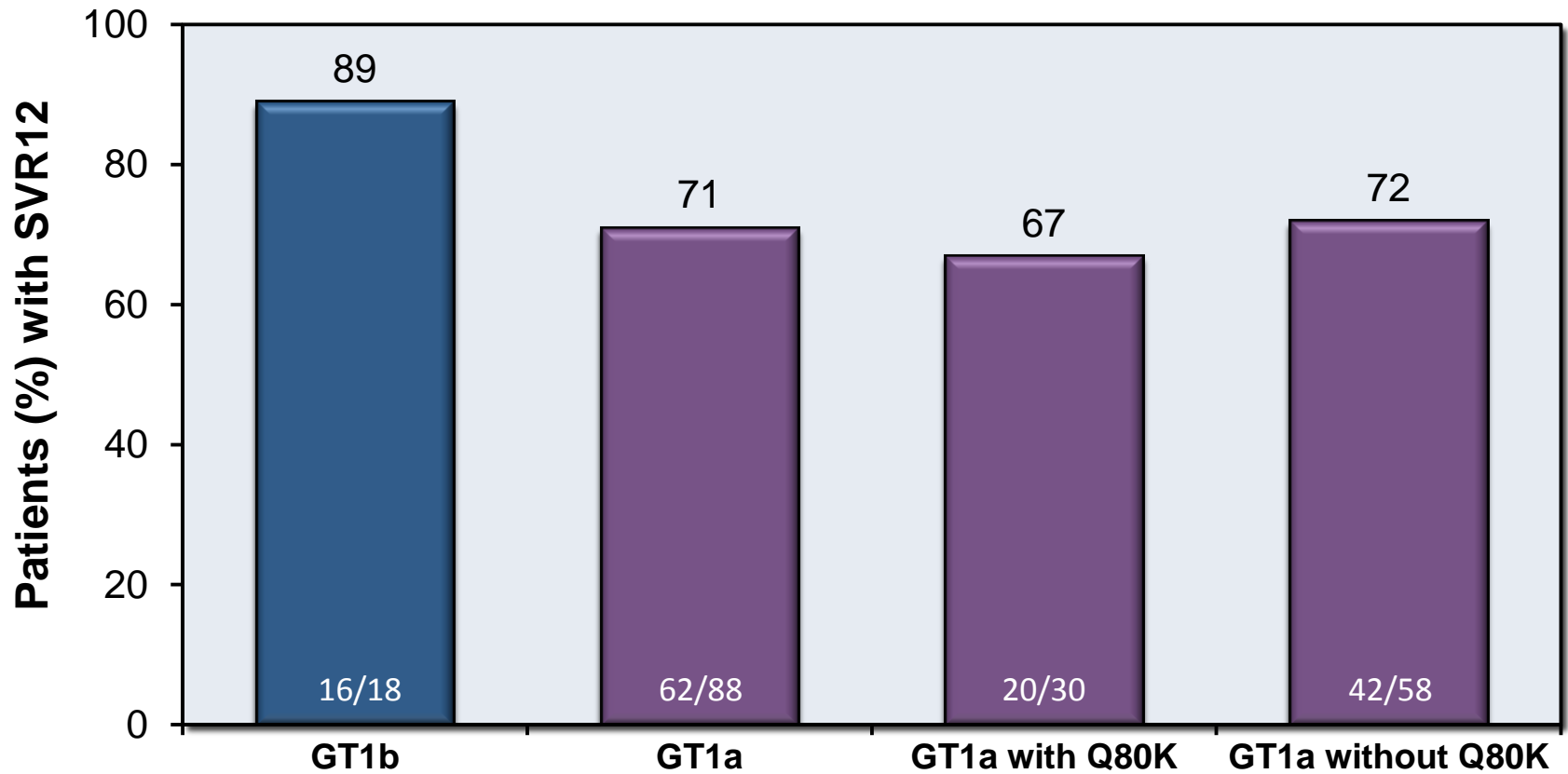

Results

SVR12 by Fibrosis Stage

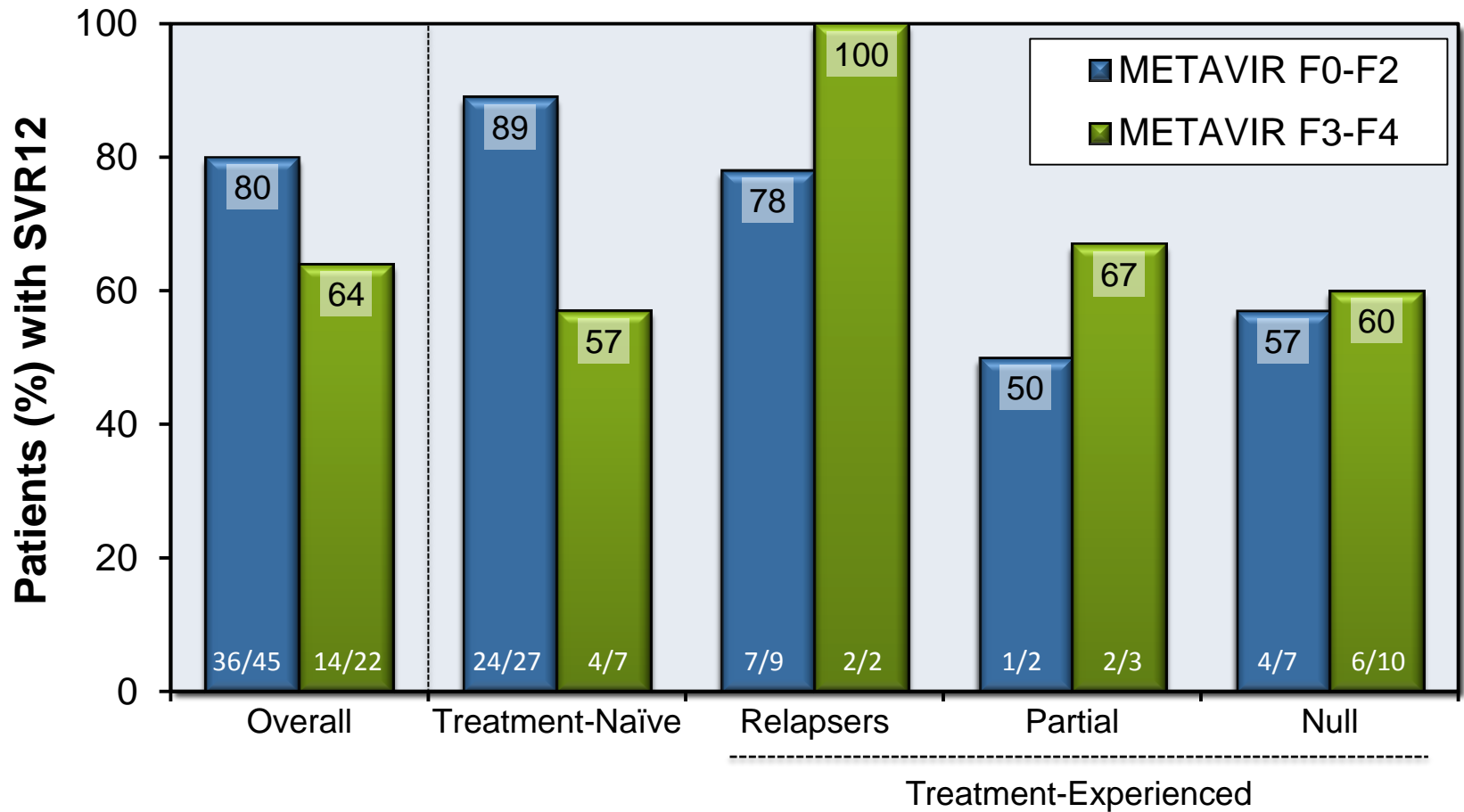

Results

SVR12 by IL28B Genotype

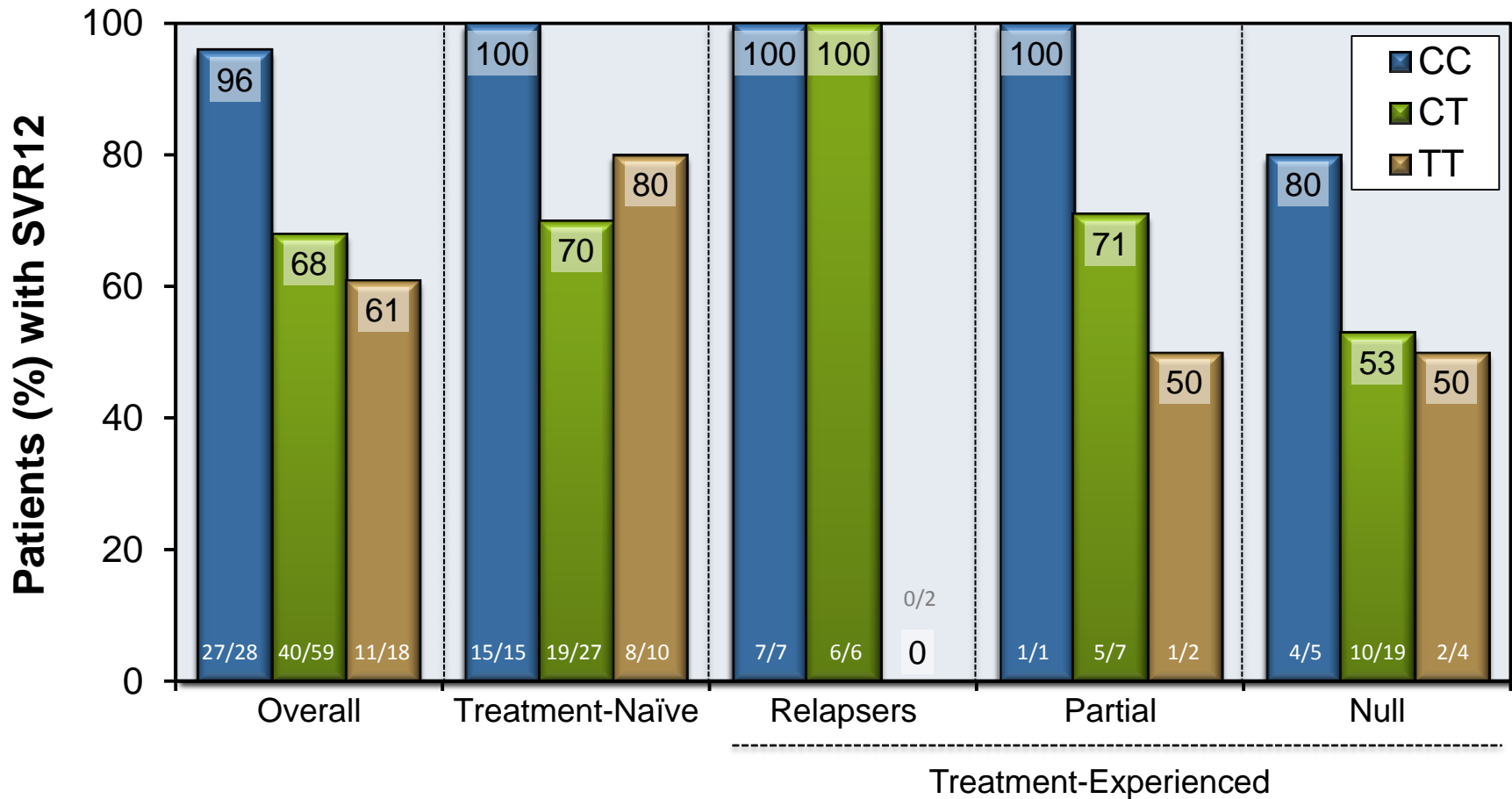

Drug–Drug Interactions With ARVs

ARV	Simeprevir
DTG	No interaction expected
RAL	Use standard doses
EFV	Do not coadminister
DLV, ETR, NVP	Do not coadminister
RPV	Use standard doses
Any PI	Do not coadminister
DRV/RTV	Do not coadminister
RTV	Do not coadminister
TPV/RTV	Do not coadminister
TDF	Use standard doses
COBI	Do not coadminister

63. Sofosbuvir [package insert]. 64. Simeprevir [package insert]. 65. Kirby B, et al. AASLD 2012. Abstract 1877. 66. Ouwerkerk-Mahadevan S, et al. IDSA 2012. Abstract 49.

Etude C212 : Résumé

- L'association SMV + PR permet d'obtenir des taux élevés de RVS12 (74 % en moyenne – extrêmes de 57 à 87 %)
- Les caractéristiques initiales n'ont que peu d'impact sur la RVS12 :
 - Score METAVIR, sous-type GT1, présence d'un polymorphisme Q80K, génotype IL28B ou taux initial de CD4
- 89 % des patients naïfs et des rechuteurs sans cirrhose ont rempli les critères du TGR et étaient éligibles à un traitement de 24 semaines
- Pas d'impact délétère sur la suppression virologique VIH
- Profil de tolérance comparable à celui des mono-infectés
 - 1,9 % (2/105) d'anémie ou d'hyperbilirubinémie
 - Rash et prurits de grade 1 ou 2 (pas d'EI jugés sérieux)

2014 EASL recommendations: how to treat ?

	Genotype 1 [#]	Genotype 4 [*]
Option 1	SOF+PR 12 w	SOF+PR 12 w
Option 2	SMV+PR 24-48 w	SMV+PR 24-48 w
Option 3	DCV+PR 24 sem (if G1b)	DCV+PR 24 w
Option 4	SOF+RBV 24 w (in case of intolerance /contraindication to IFN)	SOF+RBV 24 w (in case of intolerance /contraindication to IFN)
Option 5	SOF+SMV 12 sem	SOF+SMV 12 sem
Option 6	SOF+DCV 12-24 sem	SOF+DCV 12-24 sem

AASLD recommendations: naïve patients

3 options of similar efficacy	Genotype 1a	Genotype 1b	Genotype 4
Option 1	SOF+LDV 12 w (I, A)	SOF+LDV 12 w (I, A)	SOF+LDV 12 w (I, B)
Option 2	paritaprevir/ritonavir /ombitasvir + dasabuvir + RBV* 12 w (no cirrhosis) or 24 w (cirrhosis) (I, A)	paritaprevir/ritonavir /ombitasvir + dasabuvir 12 w Addition RBV* if cirrhosis) (I, A)	paritaprevir/ritonavir /ombitasvir + dasabuvir + RBV* 12 w (I, B)
Option 3	SOF+SMV +/- RBV 12 w (no cirrhosis) or 24 w (cirrhosis) (I, A)	SOF+SMV 12 w (no cirrhosis) or 24 w (cirrhosis) (I, A)	SOF+RBV* (24 w IIa, B)

**weight-based RBV (1000 mg [<75kg] to 1200 mg [≥75 kg])

Recommandations AFEF Janvier 2015

Génotype	Statut	Traitement	Durée	Preuve
G1b cirrhose	Naïf	Siméprévir+Sofosbuvir	12	A
	Echec Peg/Riba	Siméprévir+Sofosbuvir	12	A
G1a et G1b F2F3	Naïf et échec Peg/Riba	Siméprévir+Sofosbuvir	12	A

Génotype	Statut	Traitement	Durée	Preuve
G4 cirrhose	Naïf	Siméprévir + Sofosbuvir	12	C
	Echec Peg/Riba	Siméprévir + Sofosbuvir	12	C
G4 Fibrose F2F3	Naïf et échec Peg/Riba	Siméprévir + Sofosbuvir	12	C



Galexos® au Canada

Sovriad® au Japon et
Russie

AMM obtenue aux USA , en Europe , au
Japon, au Canada et en Russie

Merci pour votre attention